

Delta County

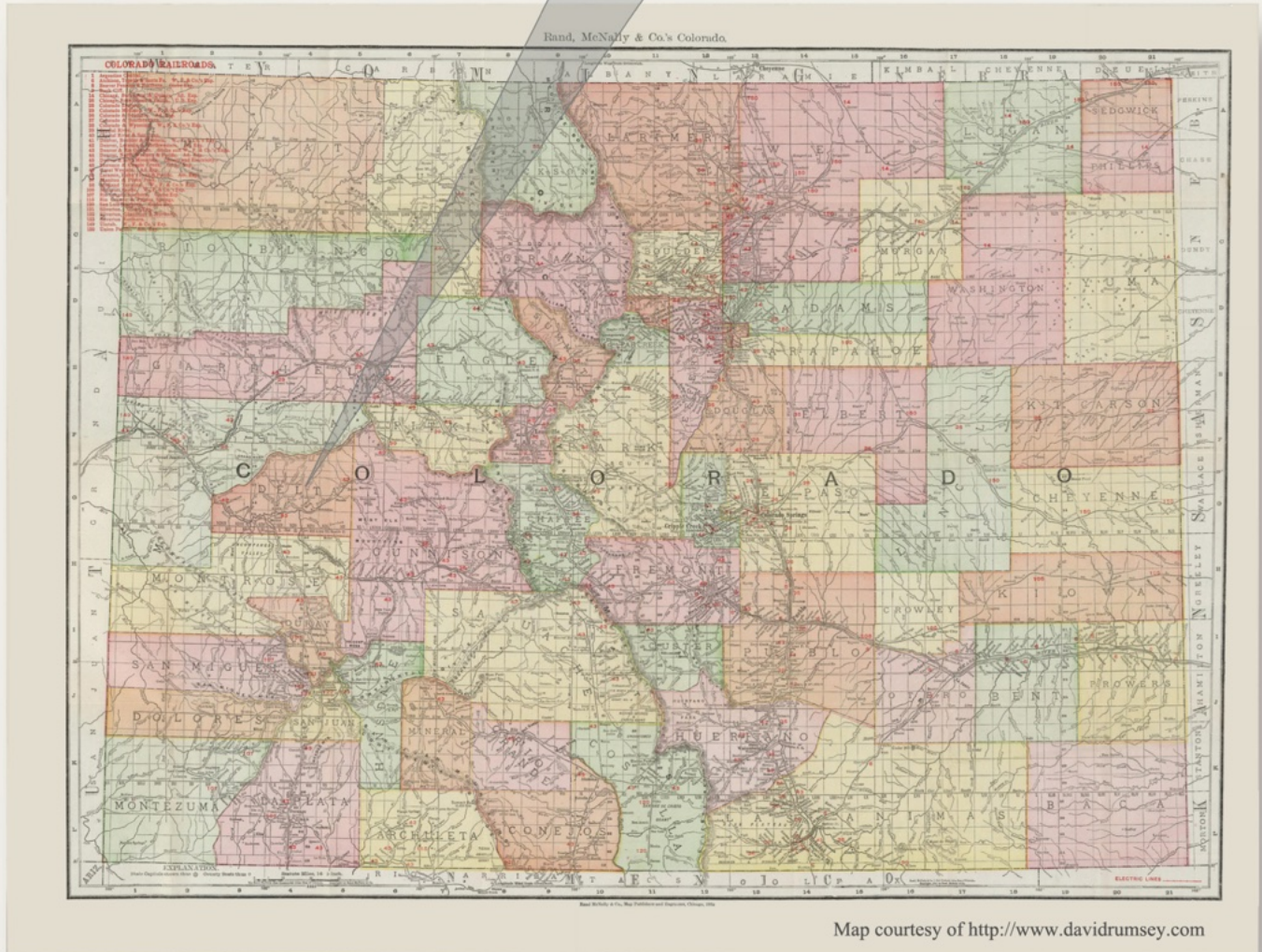

Established: February 11, 1883

County Seat: Delta

DELTA COUNTY

By William H. Bauer

Delta County lies in the west central portion of Colorado, beyond the limits of the precious metal mining districts. However, mining has played a part in the county's development. Extensive coal deposits along the North Fork of the Gunnison River have been exploited since the early days of settlement on the western slope. Most of the production was in the area from Hotchkiss northeast through Paonia and Bowie to Somerset in Gunnison County. There are still large, productive mines at Paonia, near the site of Bowie and nearby at Somerset in Gunnison County. Coal is shipped from these mines to produce electricity.

The area was slow to develop. It remained largely Ute Indian Territory until the late 1870's when, following the Meeker Massacre, the Northern Utes were removed to reservations in Utah. What is today Delta County was originally a part of Lake County, which at first reached from the Continental Divide to the Utah border. Lake County was gradually reduced with the creation of several new counties. By 1883, the area that is now Delta was included in Gunnison County. On February 11, 1883 an act of the State Legislature created Delta County with the boundaries that it still retains.

The county is a rough, right triangle in outline with an eastern, north-south boundary of approximately thirty-nine miles. The southern, east-west boundary is some forty-eight miles in length. The western boundary is less than twelve miles in length. The northern boundary is irregular and is largely dictated by the drainage divide between the Gunnison and the Colorado Rivers. This northern boundary, from 4,800-feet at the Gunnison River, climbs on to Grand Mesa to elevations approaching 11,000 feet on top of the mesa. Only three counties border Delta County: Gunnison County on the east, Montrose County on the south and west and Mesa County on the west and north.

The name of the county is a reference to the extensive, alluvial delta that was formed by the junction of the principal forks of the Gunnison River and the Uncompahgre River. This created a territory that although far from level, was not as rugged as the surrounding mountains. The river valleys became travel routes, first for the Indians and then for others travelling to the west and south.

Drainage of the county is to the west and is dominated by the Gunnison River, which enters the county from the south from the famed Black Canyon of the Gunnison. It is joined by the Smith Fork, from the east at Crawford, next by the North Fork from Somerset and Paonia and then by Surface Creek which drains the southeastern slope of Grand Mesa. The Uncompahgre River flows north out of Montrose County to join with the Gunnison at Delta.

The modern highways that serve the county are US 50, from Montrose and points east through Delta to Grand Junction and points west. Colorado Highway 92 follows the North Fork of the Gunnison to Hotchkiss where Highway 133 continues over McClure Pass and on to Glenwood Springs on the Colorado River. Colorado Highway 65 goes north from Colorado 92 through Cedaredge and crosses over Grand Mesa to the Colorado River Valley.

Railroad service for Delta County has been the province of the Denver and Rio Grande. The D&RG first built from Montrose to the Gunnison River at Delta, then down the canyon of the Gunnison to Grand Junction. A branch line was built from Delta east and north to Somerset to tap the coal mines along the North Fork of the Gunnison.

The land along the rivers was found to be fertile and quickly developed into farm and ranch land. Being somewhat protected from harsh winters, the region along the southeastern slope of Grand Mesa became a prime area for fruit orchards. That particular area is unique in Colorado, a portion of it is included in the corporate boundaries of Orchard City. However, there has never been an Orchard or

Orchard City Post Office in Delta County. This “city” has been, and is still, served by three post offices within its boundaries: Austin, Cory and Eckert.

Development in the county was largely related to agriculture; hence most of the settlements that acquired post offices were located along the rivers or other larger streams. Coalby and Suttle, on the slope of Grand Mesa, also depended on agriculture but Grand Mesa, on top of the mesa was developed as a resort and is still the site of a good number of summer cabins and small resorts. Since the origin of the county, the community of Delta has been the county’s principal city and its county seat.

Historical information about Delta County, in particular the small, short-lived communities, is sparse. Many of them have been mentioned only briefly, if at all. One, Verne, is a total mystery, with not even a Post Office Department Geographic Site Location Report for guidance.



Grand Mesa, Colorado — “Hotel Twin Lake”
Photograph by William H. Bauer September 22, 2000

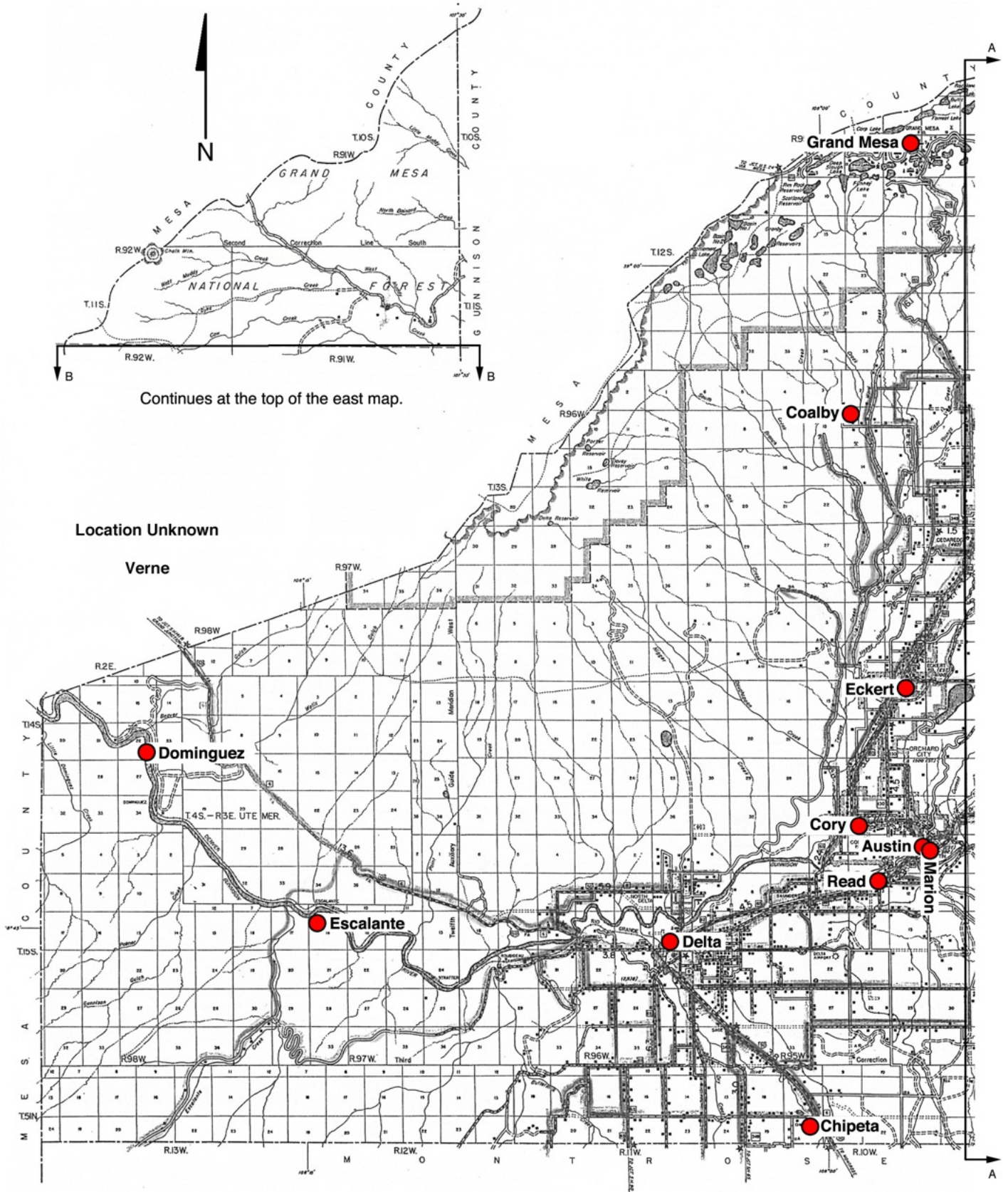

Post Office Location Map – Westen Delta County

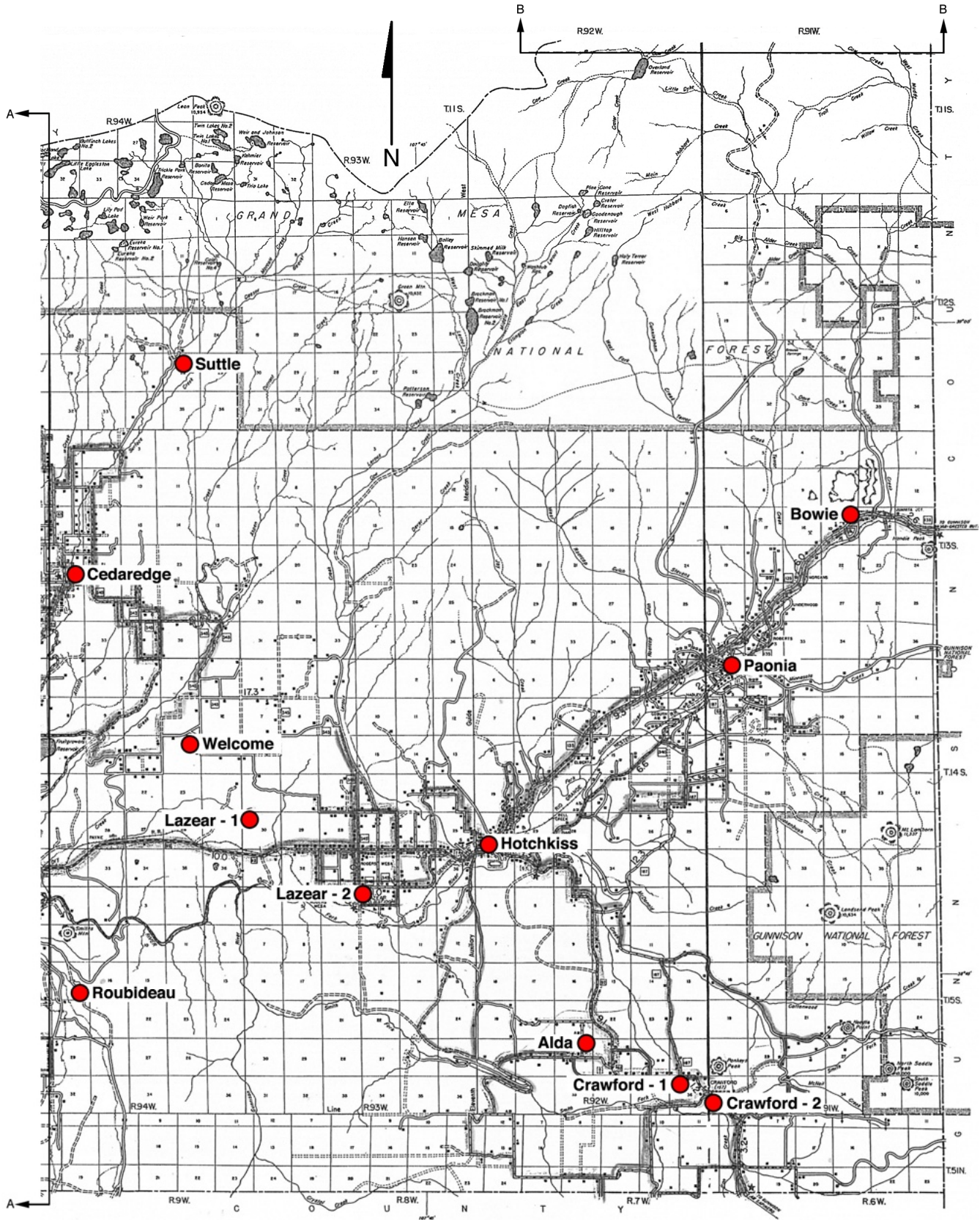

Post Office Location Map – Eastern Delta County

ALDA

Alda is one of four small settlements in Delta County that have escaped even a brief mention in the historical literature. It was located about six miles east-southeast of Hotchkiss and three miles north-northwest of Crawford.

From my visit to the site, it appears to have been a ranch post office that served a few ranches in the area between Hotchkiss and Crawford. Its short existence, less than twenty months, reinforces the thought that there was little need for the office and it is likely that it became a victim of the expanding Rural Free Delivery system.



Old log building at or near site of Alda on Delta County Highway 3675
Photograph by William H. Bauer September 22, 2000

To reach the site, from Hotchkiss and the junction with Colorado Highway 133, drive south six miles on Colorado Highway 92. Turn west one half-mile on County Road F50, then south on County Road 3675. Another half-mile brings you to the location given by the Post Office Department Geographical Site Location Report. There is an occupied ranch on each side of Road 3675. There is an old log building at the ranch on the west side of the road, which in all likelihood could date from the time of the Alda Post Office.

The surrounding countryside is rolling hills and appears to be used for livestock production. The post office name was originally suggested as Grandview but was changed to Alda by the Post Office Department. There is no indication of the source of the name but it could have been derived from the name of the first and only postmaster: Albert A. Ferrier.

ALDA – Continued**Chronology of the Post Office**

No Date	---	NE/4 Sec 28 T15S R92W Applicant for postmaster - A. A. Ferrier Name requested was GRANDVIEW, Alda substituted
May 2 1913		Established
May 2 1913		Ferrier, Albert A.
Dec 15 1914		Discontinued Mail to Hotchkiss

Confirmed types of postal markings

NO POSTAL MARKINGS HAVE BEEN REPORTED FROM ALDA

AUSTIN

The community of Austin was established in 1900 when Dr. Austin E. Miller provided land for the townsite and the right-of-way for the Denver and Rio Grande Railroad. Dr. Miller was from Iowa and suffered from tuberculosis. He came to Colorado seeking better health, acquired considerable land holdings in the area east of Delta and became involved in ranching and the fruit growing industry. The community was named for Dr. Austin Miller.

Austin developed into a modest sized village with a number of businesses that served the surrounding ranchers and farmers. It also had a railroad depot at which, produce from the Surface Creek region was shipped to market.

Today Austin is still an occupied community with facilities for packing and shipping fruit. The village is located a few hundred yards north of Colorado Highway 92, about six miles east of Delta.

Latitude = 38:46:52 North Longitude = 107:57:01 West

Chronology of the Post Office

Feb 13 1905	---	NE/4 Sec 1 T15S R95W 1/2 mile north of the Gunnison west of Alfalfa Run	
May 19 1905		Established	
May 19 1905		Gutschall, Charles D.	
Feb 6 1907		Schneider, Ida D.	
Jan 12 1910		Landreth, Elmer E.	
Jan 12 1912		Landreth, Ralph E.	
Apr 12 1913		McFadden, Harriet A.	
Apr 8 1914	---	NW/4 Sec 6 T15S R94W 1/4 mile north of the Gunnison River 1/2 mile west of Dry (Currant) Creek	
Apr 1 1922			Office made Presidential
Dec 23 1922		Ritter, Flossy H.	
Sep 9 1925		McFadden, Harriet A.	Acting
Oct 7 1925		Hinman, Ida E.	Acting
Jan 14 1926		Storment, John V.	
Jul 1 1926			Relegated
Jul 14 1926		Storment, John V.	
Mar 1 1941		Callahan, Mrs. Minnie	Assumed charge
Mar 6 1941		Callahan, Mrs. Minnie	Acting
Jul 15 1941		Callahan, Clarence H.	Confirmed
Aug 8 1941		Callahan, Clarence H.	Commissioned
Aug 28 1941		Callahan, Clarence H.	Assumed charge
Oct 21 1941	---	NW/4 NW/4 Sec 6 T15S R94W	
Aug 24 1943		Drysdale, Mrs. Lillian M.	Acting
Aug 25 1943		Drysdale, Mrs. Lillian M.	Assumed charge
Sep 1 1943		Drysdale, Mrs. Lillian M.	Acting
Jul 6 1944		Drysdale, Mrs. Lillian M.	Appointed & Confirmed

AUSTIN – Continued

Jul 24 1944	Drysdale, Mrs. Lillian M.	Commissioned
Jul 31 1944	Drysdale, Mrs. Lillian M.	Assumed charge
Aug 28 1944 ---	NW/4 Sec 6 T15S R94W	
Sep 26 1945	Drysdale, Mrs. Lillian M.	Nominated
Oct 29 1945	Drysdale, Mrs. Lillian M.	Confirmed
Oct 30 1945	Drysdale, Mrs. Lillian M.	Appointed Presidential
Mar 31 1946	Drysdale, Mrs. Lillian M.	Assumed charge
Oct 30 1946	Drysdale, Mrs. Lillian M.	Commissioned
Oct 31 1966	Kettle, Mrs. Ida J.	Acting
May 8 1967	Kettle, Mrs. Ida J.	Nominated & Appointed
May 19 1967	Kettle, Mrs. Ida J.	Commissioned & Assumed charge
Nov 29 1874	Stefan, Mrs. Edna L.	Officer in charge
Mar 29 1975	Myers, Audrey K.	Appointed

Confirmed types of postal markings

1 AUSTIN, / COLO. CI 10P 31.0	Doane Type 3 with 1, S-24x14mm	Jan 29 1907 Mar 7 1918
2 AUSTIN / COLO. CI 10P 32.0	4bars S-23x14mm	Sep 8 1910 Aug 15 1932
3 AUSTIN / COLO. CI 10P 29.0	Dplx Grid, 9-bar oval	Feb 15 1933
4 AUSTIN / COLO. CI 10P 33.0	4bars S-24x20mm	Jan 18 1933 Feb 28 1950
5 AUSTIN / COLO. CI 10P 30.0	Dplx Grid, diamond with 1	Sep 22 1950 Apr 6 1964
6 AUSTIN / COLO. CI 11P 30.0/19.5	Hstp No killer	1955 Jun 23 1958
6.1 AUSTIN / COLO. CI 10P 33.0	4bars S-??x20mm	Jan 4 1965
7 AUSTIN, CO / 81410 CI 10P 32.0	4bars S-24x20mm	Sep 8 1970 May 29 1993
8 AUSTIN CO / 81410 CI 10P 20.0	Mach 7 wavy lines	Jul 9 1981 Jun 22 1990

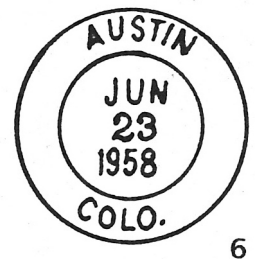
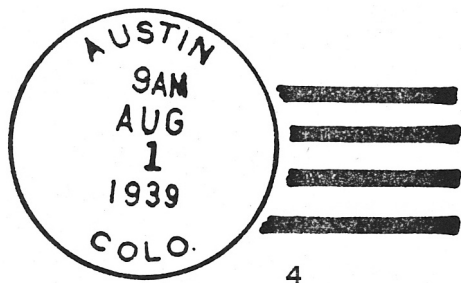
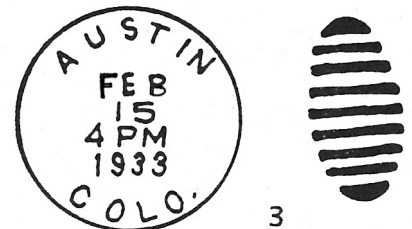
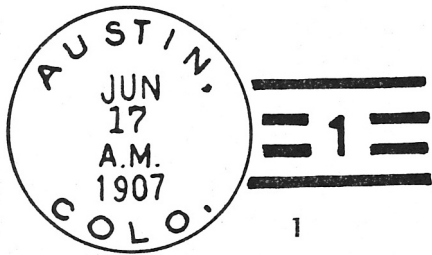

AUSTIN – Continued

**BOWIE**

Bowie has always been a coal camp. It was a creation of the Juanita Coal & Coke Company and although I have not seen confirmation, I believe the Juanita was related to Juanita, Pennsylvania. The original name applied to the community was Reading, another tieback to the coal fields of Pennsylvania. There is also one reference that claims another early name for the settlement was Wauneta but that is more likely a mis-statement of Juanita.

When the post office was established in 1907, it could not use the name Juanita because there was an operating post office with that name in Archuleta County. The name that was adopted honored Alexander Bowie, who operated coal mines in the east and the west and in 1906 was involved in the development of the mine at Bowie. Alexander Bowie died in 1917 and operation of the mine passed to his four sons. They continued operation until 1974 when the Juanita Coal and Coke Company was sold to the Adolph Coors Company of Golden, Colorado. I do not know who currently owns the mine.

From its inception Bowie was a company town and it is claimed that Coors did not realize that the purchase of the coal mine also included the town. The Bowie Post Office had closed in 1967 and it is possible that Coors was not enthusiastic about owning a town and they may have discouraged continued residence.

I visited Bowie in September 2000 and at that time there were still a few scattered, small residences that appeared to be occupied. The mine at Bowie is located several hundred feet up the north side of the valley above Bowie. Coal is trucked down a steep road from the mine and onward to the railroad at Paonia for shipment.

The entrance to Bowie is about four miles east of Paonia on the north side of Colorado Highway 133. I believe that this road was the original Colorado 133, which has been relocated and greatly improved. I thought that this road would reconnect to 133 but three miles east of Bowie I was still on the old road.

Latitude = 38:55:17 North Longitude = 107:32:22 West

Chronology of the Post Office

Jan 2 1907	---	NE/4 Sec 15 T13S R91W	
Feb 5 1907		Established	
Feb 5 1907		Bowie, Alexander	
Apr 7 1914	---	SW/4 NE/4 Sec 15 T13S R91W	
Feb 11 1917		Bowie, John S.	Acting
Jul 16 1917		Bowie, John S.	Appointed
Aug 15 1917		Bowie, John S.	Commissioned
Aug 21 1917		Bowie, John S.	Possession
Oct 21 1941	---	NE/4 Sec 15 T13S R 91W	
Mar 26 1945		Kuretich, Mrs Ruby P.	Acting
Feb 28 1945		Kuretich, Mrs Ruby P.	Possession
May 17 1946		Kuretich, Mrs Ruby P.	Appointed

BOWIE – Continued

Jun 27 1946	Kuretich, Mrs Ruby P.	Commissioned
Jul 12 1946	Kuretich, Mrs Ruby P.	Possession
Dec 29 1965	Delimont, Mrs Ruby M.	Acting, Possession
Mar 25 1966	Sims, Mrs Josephine M.	Possession
Jun 23 1966	Ordered closed Mail to Paonia effective Jul 1 1966	
Jun 30 1966	Closing order rescinded	
Jun 1 1967	Ordered closed	
Jul 14 1967	Discontinued Mail to Paonia	

Confirmed types of postal markings

1	BOWIE, / COLO. CI 10P 30.5	4bars S-23x13mm	Apr 5 1910 Aug 30 1912
2	BOWIE, / COLO. CI 10P 31.0	4bars S-??x19mm	Mar 31 1913 Feb 4 1916
3	BOWIE. / COLO. CI 10P 32.0	4bars S-24x20mm	Feb 3 1931 Feb 13 1933
4	BOWIE / COLO. CI 10P 32.0	4bars S-23x19mm	Nov 5 1938 Nov 16 1942
5	BOWIE / COLO. CI 10P 32.0	4bars S-23x17mm, close spaced letters	Jul 9 1947 Dec 5 1955
6	BOWIE / COLO. CI 11P 29.0/19.0	Hstp No killer	Feb 15 1956
7	BOWIE / COLO. CI 10P 32.0	4bars S-24x19mm, wide spaced letters	Jan 10 1962
8	BOWIE, CO / 81412 CI 10P 33.0	4bars S-25x19mm	May 4 1965 Jul 14 1967



1

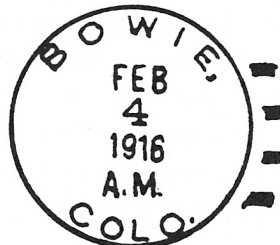

2

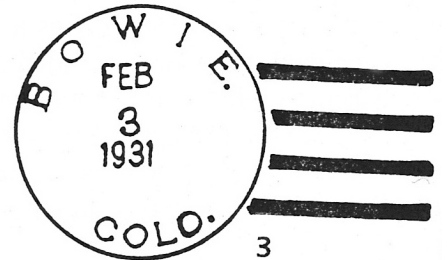

3

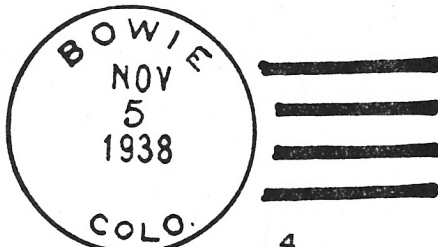

4



5

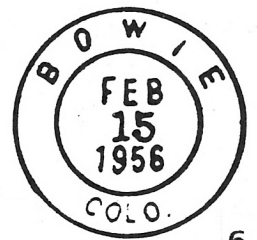

6

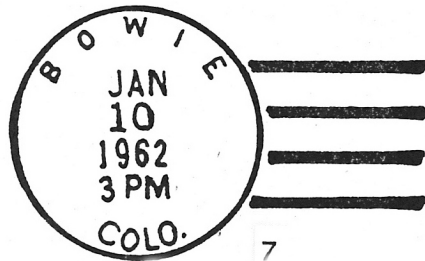

7

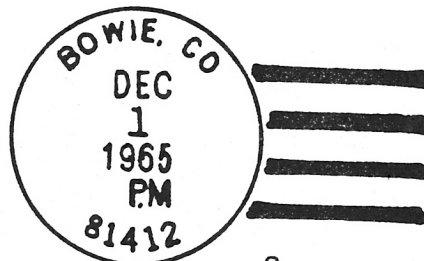

8

CEDAREEDGE

Cedaredge is the principal town along Colorado Highway 65, the road to Grand Mesa. Settlement began in 1882 on the ranch of Henry Kohler. Kohler named his ranch Cedar Edge, as it was located on the edge of a band of cedar trees on the southeastern slope of Grand Mesa. 1894, when a post office was requested, was during a period of time when the Post Office Department was actively discouraging long and multiple word names for post offices - the shorter the better. Hence, Cedar Edge was reduced to Cedaredge.

Around 1890 the community began to grow and John Zainetti was engaged in the sale of building lots on a ten-acre townsite that had been set aside. A vote to incorporate Cedaredge was held in March 1907 and the town has gradually grown from the original ten acres to approximately a square mile (640 acres).

Cedaredge is an active community with businesses serving the surrounding ranch and farming country. There is also a small Pioneer Museum in Cedaredge, which includes several old log buildings. An annual festival, Pioneer Days, celebrates the area's past history and has been subject of special commemorative postmarks.

The book, *Surface Creek Country* by Hazel Baker Austin, details the history of the Cedaredge Post Office. From her description it would seem that almost every time the postmaster changed, the post office moved to a new location within Cedaredge. My first visit to Cedaredge was in 1972 at which time the post office occupied a neat but small brick building. By the fall of 2000 the post office had moved again, to a larger more impressive brick building where it seems likely to remain for the future. It is on a side street, one block south of Main Street and to the west of Colorado Highway 65.

To reach Cedaredge drive about three miles east from Delta on Colorado Highway 92. Turn north on Colorado 65 towards Grand Mesa and it is about 10 miles to Cedaredge. The town is sited on the slope of Grand Mesa at a point just before Colorado 65 becomes a winding road climbing up on to the mesa.

The countryside surrounding Cedaredge is largely ranchland with some farming and orchard production in the lower and more sheltered elevations. Since its inception, the town has served the agricultural community. It continues to do so today, but it also provides services and shopping for tourists and the recreational activities on Grand Mesa.

Latitude = 38:54:06 North Longitude = 107:55:33 West

Chronology of the Post Office

Oct 5 1894	---	SW/4 Sec 20 T13S R94W 100 feet north of Surface Creek	
		Proposed Postmaster - Mrs. Kate T. Lovett	
Dec 5 1894		Established	
Dec 5 1894		Lovett, Mrs Kate T.	
Sep 16 1895		Butsford, Alfred C.	
Nov 1 1898		Frank, Margaret	
Mar 6 1899	---	NW/4 NE/4 Sec 29 T13S R94W 1/4 mile west of Surface Creek	
Apr 4 1902		Hogrefe, Joseph	
Apr 11 1907		Baker, Homer W.	
Jan 31 1908		Johnson, Cornelius M.	
Jul 15 1909		Cobbett, Harvey A.	
Feb 17 1911		Cobbett, Harvey A.	P&S [Apptd by President & Confirmed by Senate]
Feb 26 1914	---	NW/4 Sec 29(?) T13S R94W 80 rods west of Surface Creek	
Mar 3 1915		Childs, Frank W.	P&S
Aug 5 1919		Childs, Frank W.	P&S
Jul 15 1922		Overhuls, Alice	Acting
Mar 3 1923		Cobbett, Harry A.	
Feb 16 1927		Cobbett, Harry A.	

CEDAREEDGE – Continued

Apr 1 1932	Stewart, Frank J.	Nominated
Apr 27 1932	Stewart, Frank J.	Confirmed
May 28 1932	Stewart, Frank J.	Commissioned
Jun 5 1932	Stewart, Frank J.	Assumed charge
Aug 3 1933	James, Robert P.	Acting
Aug 21 1933	James, Robert P.	Assumed charge
Apr 18 1934	James, Robert P.	Nominated
Apr 25 1934	James, Robert P.	Appointed & Confirmed
Jun 4 1934	James, Robert P.	Commissioned
Apr 29 1938	James, Robert P.	Nominated
May 3 1938	James, Robert P.	Confirmed
May 6 1938	James, Robert P.	Appointed Presidential
Jun 8 1938	James, Robert P.	Commissioned
Oct 30 1941 ---	SE/4 Sec 20 T13S R94W Surface Creek	150 yards east of office
Jul 23 1942	James, Robert P.	Nominated
Aug 25 1942	James, Robert P.	Confirmed
Aug 26 1942	James, Robert P.	Appointed Presidential
Sep 18 1942	James, Robert P.	Commissioned
Sep 30 1942	James, Robert P.	Possession
Aug 31 1948	Keen, Mrs. Lela C.	Acting
Sep 1 1948	Keen, Mrs. Lela C.	Acting
Apr 28 1949	Keen, Mrs. Lela C.	Nominated
Jun 1 1949	Keen, Mrs. Lela C.	Confirmed
Jun 2 1949	Keen, Mrs. Lela C.	Appointed Presidential & Commissioned
Sep 30 1949	Keen, Mrs. Lela C.	Assumed charge
Jan 10 1954	Aust, Mrs. Lela C.	Name changed by marriage
Mar 31 1972	Hart, Judd O.	Officer in charge
May 13 1972	Hart, Judd O.	Appointed
May 13 1972	Hart, Judd O.	Assumed charge
Oct 10 1975	Wallace, Ralph P.	Officer in charge
Jul 3 1976	Mills, Mrs. Margaret L.	Appointed
Oct 9 1979	Murphy, Darrel L.	Officer in charge
Feb 9 1980	Morman, Mrs. Charlene F.	

Confirmed types of postal markings

1	CEDAREEDGE / COLO CI 10P 27.0	Hstp Not present	Mar 31 1899
2	CEDAREEDGE / COLO. CI 10P 27.5	Hstp Not present	Jun 24 1901
3	CEDAREEDGE, / COLO. CI 10P ???	Doane Type 1, with 3; [PARTIAL ILLUSTRATION]	Jan 26 1904 Jan 24 1905
4	CEDAREEDGE, / COLO. CI 10P 29.0	4bars Not recorded [NOT AVAILABLE FOR ILLUSTRATION]	Jan 24 1905 Jul 27 1910
5	CEDAREEDGE, / COLO. CI 10P ???	Doane Type 2, with ?; [NOT AVAILABLE FOR ILLUSTRATION]	Nov 21 1906 Nov 22 1906
6	CEDAREEDGE / COLO. CI 10P 30.0	Hstp 4 double “sine-wave bars,” P-20x15mm, top and bottom bars only 15mm long [NOT AVAILABLE FOR ILLUSTRATION]	Nov 26 1906
6.1	CEDAREEDGE, / COLO. CI 10P 35.0	Hstp 4 sine-wave bars, P-20x?mm, [used as transit cancel on Coalby Doane]	Jul 18 1907 Jul 18 1907

CEDAREEDGE – Continued

6.2	CEDAREEDGE, COLO / REC'D CI 10P 34.0	Hstp No killer	Jan 16 1908
7	CEDAREEDGE / COLO. CI 10P 32.0	4bars S-24x14mm	Jul 18 1908 Mar 7 1911
8	CEDAREEDGE / COLO. CI 10P 30.0	Dplx Grid, 8-bar oval; small letters	Sep 19 1911 Oct 21 1918
8.1	CEDAREEDGE, / COLO. RC 10P 37.0x15.0	Hstp No killer, Parcel Post Box	1920s
9	CEDAREEDGE / COLO. CI 10P 29.0	Dplx Grid, 9-bar oval; large letters	Jan 1 1924 Dec 11 1935
9.1	CEDAREEDGE / COLO. CI 10P 26.5	Dplx Grid, Oval with 1	Feb 13 1938
10	CEDAREEDGE / COLO. CI 10P 23.0	Mach 7 wavy lines; squared letters	Sep 12 1938 Nov 4 1952
11	CEDAREEDGE / COLO. CI 10P 30.0	Dplx Grid, pointed oval with 1	Dec 10 1938 Mar 9 1952
12	Cedareedge / COLO. RC 10P 36.0x17.0	Hstp No killer, Parcel Post Box style	--- -- 1940s
13	CEDAREEDGE / COLO. CI 10P 21.0	Mach 6 wavy lines; rounded letters	Dec 18 1963
14	CEDAREEDGE, CO / 81413 CI 10P 32.0	4bars S-23x18mm	Oct 8 1971 Oct 10 1972
15	CEDAREEDGE, CO / 81413 CI 10P 21.0	Mach 6 wavy lines	Sep 7 1968 May 9 1995
16	CEDAREEDGE, CO / 81413 CI 10P 33.0	4bars S-26x20mm	Apr 10 1987 Mar 18 1988
17	CEDAREEDGE / COLORADO SL 00R 21.0x14.0	Pict Scene at left w/text; 100th Anniversary / 1894-1994. 6-bars at right, Text over Date stamp: U. S. POST / OFFICE	Dec 4 1994
18	CEDAREEDGE CO / 81413 CI 10P 34.0	4bars S-20x16mm	Mar 19 1995 Aug 5 1995
19	CEDAREEDGE CO 81413 / USPS CI 11P 30.0/19.0	Hstp No killer	Mar 28 1996



1



2



3



6.1



6.2

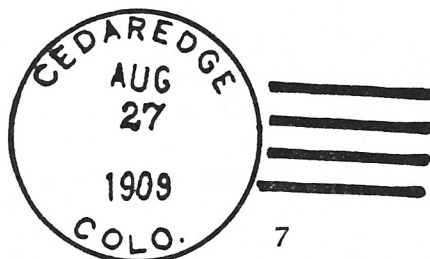

7



8

CEDAREdge – Continued



8.1

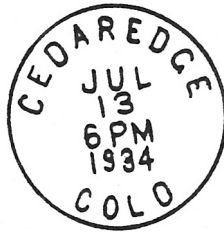

9

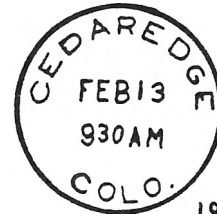

1938



9.1



10

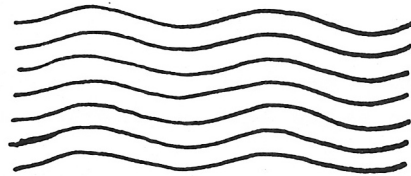

11



12



13

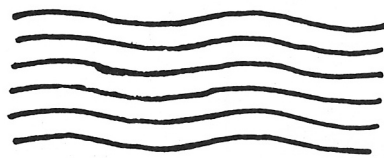

14



15



16



17

U.S. POST
OFFICE
CEDAREdge
COLORADO
81413
Dec 4th 1994

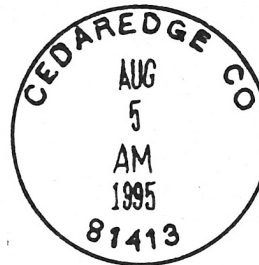

18

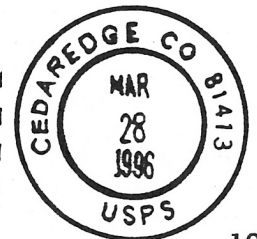
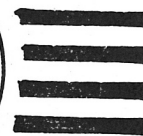

19

CEDAREdge STATIONS

APPLE FEST STATION

Chronology of the Post Office

Oct 2 1993

Operated as a Special Commemorative Station

CEDAREGE STATIONS – Continued

APPLE FEST STATION – Continued

Confirmed types of postal markings

- 1 Cedaredge Colorado 81413 // APPLE FEST Sta. Oct 2 1993
SL 00R 54.0x20.0 Pict Scene - Basket of apples



1

PIONEER TOWN STATION

Chronology of the Post Office

- May 28 1994 Operated as a Special Commemorative Station
- May 27 1995 Operated as a Special Commemorative Station
- May 25 1996 Operated as a Special Commemorative Station

Confirmed types of postal markings

- 1 Cedaredge, Colorado / 81415 // Visit / PIONEER / TOWN / STATION / in May 28 1994
RC 10P 117.0x30.0 Pict Scene - framed, three silos at left, meridional globe at right
- 2 CEDAREGE / CO 81413 :: Pioneer / Town / Station May 27 1995
SL 00R 48.0x21.0 Pict No scene or additional text
- 3 Cedaredge, Colorado / 81413 // Pioneer Town Station May 25 1996
SL 00R 95.0x20.0 Pict Scene - Steam engine in box at left, Date appears as May 25-27



1



Pioneer Town Station
May 25-27, 1996
Cedaredge, Colorado
81413



3

Pioneer CEDAREGE
Town CO 81413
Station MAY 27 1995

2

CHIPETA

Chipeta, the wife of famed Ute chieftain Ouray, has had her name used for three different post offices in Colorado. All three offices lasted less than one year. One was in Montrose County and after eleven months its name was changed to Naturita. Another was in Pitkin County on the western side of Independence Pass. It was located in the mining community known as Independence but whose post office was at various time named Sidney, Farwell and Sparkill, in addition to Chipeta. There was also, for several years, a Chipeta Park Post Office in El Paso County.

CHIPETA – Continued

This particular Chipeta was southeast of Delta and just north of the Montrose County line. It was a station on the Denver and Rio Grande Railroad but other than that it has received no mention in the historical literature.

As stated, the site is just north of the Delta-Montrose County line, on US Highway 50. There is a large ranch in the vicinity on the east side of the highway but the buildings there are of more modern construction than the brief period of the Chipeta Post Office. I can but assume that this was an attempt to provide a postal facility for the ranches and farmers in the area between Olathe and Delta. The establishment was rescinded, perhaps because of the growth of the Rural Free Delivery system, thus it seems unlikely that the office was ever in operation.

Chronology of the Post Office

Jun 14 1895	Established	
Jun 14 1895	Lauzon, Mary C.	Order rescinded Sep 7 1895
Sep 7 1895	Discontinued	

Confirmed types of postal markings

NO POSTAL MARKINGS HAVE BEEN REPORTED FROM CHIPETA

COALBY

The Coalby Post Office was located about three miles northwest of Cedaredge. Andrew Watson developed whatever community existed, petitioned for the post office and was the first postmaster. He suggested the name Coalby because of some nearby coal mines. These mines were small and were not significant producers. Today the area is largely devoted to farming and ranching.

The Coalby Post Office closed in 1912, a victim of the expanding Rural Free Delivery system.

To reach the site of Coalby, from Cedaredge drive west on Main Street a little more than two miles to the intersection with Delta County Road 2075 to the north. Main Street may actually be a continuation of Road 2075. Turn right about three miles to County Road T50. Turn left and in about one half-mile you will cross Williams Creek. Coalby was located on the east side of the creek. There is a fairly new house there with some associated older structures. There is a nice mix of new homes and decrepit barns in the area, so it appears that the area no longer depends on agriculture but has become more residential in nature.

Chronology of the Post Office

Feb 12 1906	---	NW/4 Sec 11 T13S R95W 75 yards east of Williams Creek
		Proposed postmaster - Andy J. Watson
Apr 11 1906		Established
Apr 11 1906		Watson, Andy J.
Jan 8 1908		Fickes, Frank A.
Aug 15 1912		Discontinued Mail to Cedaredge

Confirmed types of postal markings

1	COALBY, / COLO.	Jul 20 1907 Jun 30 1911
	CI 10P 30.0	Doane Type 3 with 1, S-??x13mm

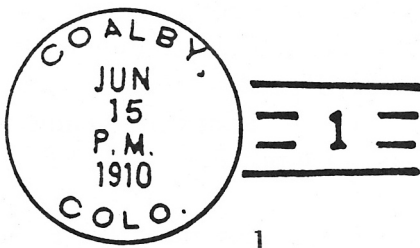

CORY

Cory is one of the three post offices within the boundaries of Orchard City. Like Cedaredge it has, according to Hazel Baker Austin, had a peripatetic existence, moving frequently with the changes of postmaster. In the early 1950's Colorado Highway 65 was relocated, bypassing much of the community. At the time Bertha Lugar was postmaster, operating the post office in the family store with her husband Tom. In 1953 the Lugars built a new store on the relocated highway and the post office was still operating at that location in September 2002.

This portion of Delta County is agricultural with fruit growing a major business activity.

To reach Cory, drive east from Delta on Colorado Highway 92 and turn north on Colorado Highway 65. From the intersection it is about two miles to Cory. The combination store, gas station and post office is on the east side of Highway 65. As a post office it is not all that obvious. This was another instance where I was having difficulty finding the post office, stopped and went into the store, asked the clerk where the post office was located and was informed that, "I was standing in it."

The present day community of Cory consists of a number of residences scattered over a square mile or more. There are also some small businesses related to the agricultural industry.

Latitude = 38:47:17 North Longitude = 105:91:20 West



Cory, Colorado — Cory General Store and Post Office
Photograph by W. H. Bauer September 22, 2000

Chronology of the Post Office

Mar 2 1895	---	SW/4 Sec 35 T14S R95W	1/2 mile east of Tongue Creek
Mar 12, 1895		Established	
Mar 12 1895		Crow, Elmer F.	
Jun 30 1896		Harshman, Cora	

CORY – Continued

Jul 13 1901	Hawker, Henry	
Dec 8 1902 ---	SE/4 Sec 35 T14S R95W	
Mar 27 1903	Hawker, Kate	
Jun 5 1903	Gilmer, Lulu E.	
Jul 12 1905	Paterson, Margaret E.	
Apr 27 1907	McDowell, Leander L.	
Feb 21 1911	McCarrier, Eugene L.	
Feb 26 1914 ---	SW/4 Sec 35 T14S R95W 1 mile north of the Gunnison River 1/2 mile east of Tongue Creek	
Sep 10 1914	McCarrier, Maggie B.	
Jan 22 1917	Dixon, Ruth A.	
Feb 6 1920	Whiteside, John F.	
Dec 28 1926	Stewart, Mrs Clara A.	Acting
Jun 15 1927	Stewart, Mrs Clara A.	Appointed
Jun 29 1927	Stewart, Mrs Clara A.	Commissioned
Jul 1 1927	Stewart, Mrs Clara A.	Possession & Assumed charge
Oct 20 1941 ---	SW/4 Sec 35 T14S R95W Gunnison River 3/4 mile south 1/2 mile west of office	Tongue Creek
Aug 31 1950	Lugar, Thomas B.	Possession & Assumed charge
Sep 13 1950	Lugar, Thomas B.	Acting & Appointed
Dec 7 1951	Lugar, Mrs. Bertha E.	Appointed & Confirmed
Jan 21 1952	Lugar, Mrs. Bertha E.	Commissioned
Jan 30 1952	Lugar, Mrs. Bertha E.	Possession & Assumed charge
Dec 30 1966	Helmick, Mrs. Carolie E.	Acting
Jul 27 1967	Helmick, Mrs. Carolie E.	Commissioned
Aug 4 1967	Helmick, Mrs. Carolie E.	Possession & Assumed charge

Confirmed types of postal markings

1	CORY / COLO. CI 10P 27.0	Hstp negative crossroads	Nov 30 1896 Feb 12 1897
2	CORY / COLO. CI 10P 28.5	Doane Type 2 with 2, S-24x13mm	Dec 6 1905 Feb 13 1911
3	CORY, / COLO. CI 10P 28.0	Hstp No killer	Sep 10 1908
4	CORY, / COLO. CI 10P 31.0	4bars S-24x19mm	Aug 30 1912 Nov 25 1932
5	CORY, / COLO. CI 10P 34.0	4bars S-24x20mm	Feb 20 1933 Jun 10 1942
6	CORY / COLO. CI 10P 32.0	4bars S-23x19mm	Sep 30 1943 Oct 5 1957
7	CORY / COLO. CI 10P 33.0	4bars S-??x18mm	Nov 3 1956 Feb 19 1962
8	CORY / COLO. CI 11P 29.0/19.5	Hstp No killer	May 18 1967
9	CORY, CO / 81414 CI 10P 31.0	4bars S-23x18mm	Apr 14 1970 Jan 27 1976
10	CORY, CO / 81414 CI 10P 34.0	4bars S-25x20mm	Nov 21 1977 Mar 26 1987
11	CORY, CO / 81414 CI 10P 33.0	4bars S-24x20mm	Dec 9 1991 May 10 1993
12	CORY CO / 81414 CI 10P 32.0	4bars S-24x18mm	Mar 30 1996

CORY - Continued

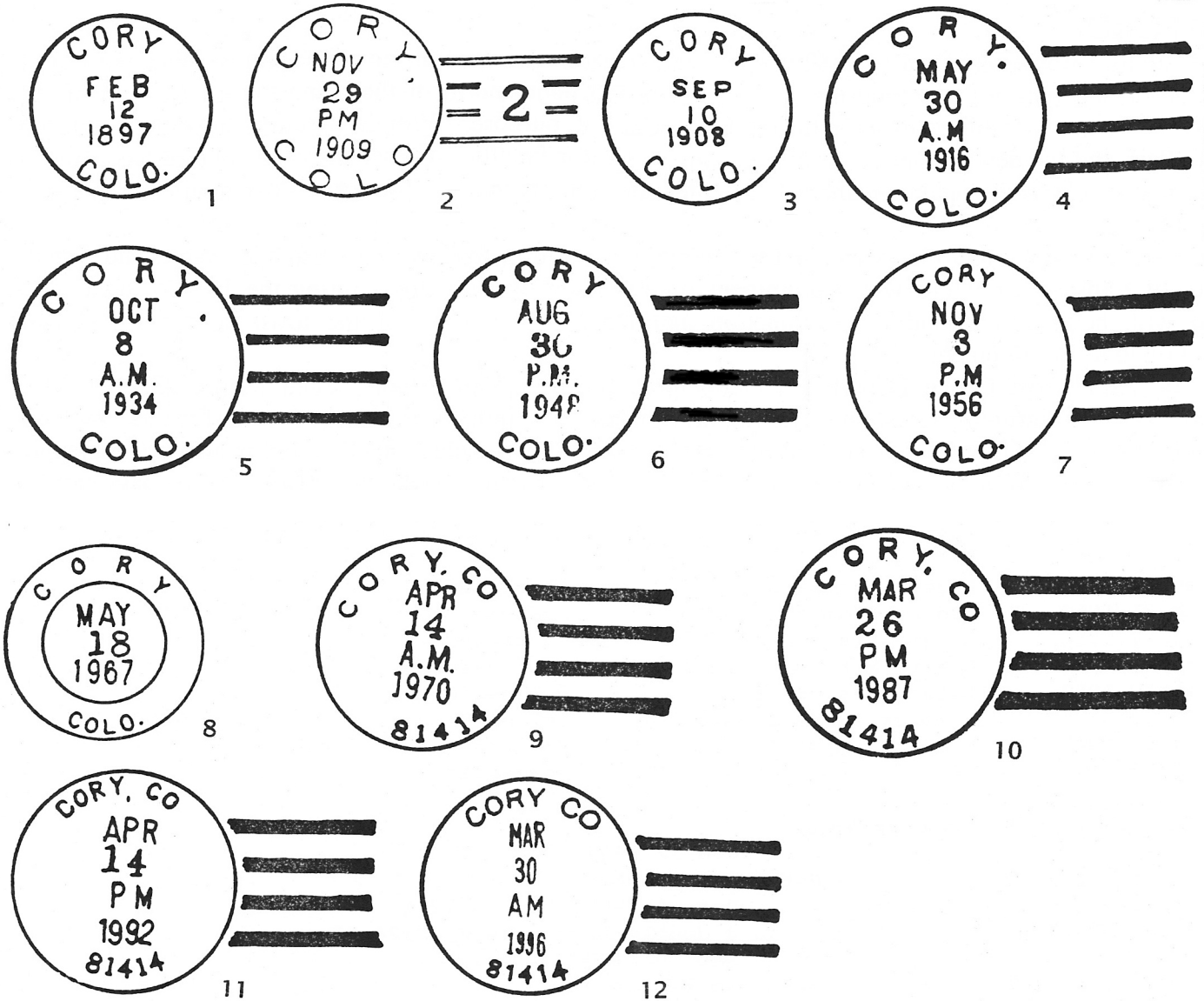

CENTENNIAL STATION

Chronology of the Post Office

Mar 12 1995 Operated as a Special Commemorative Station

Confirmed types of postal markings

- 1 CORY, CO :: CENTENNIAL STATION Mar 12 1995
IR 00R 82.0x17.0 Pict Scene - Road and mountains; Text - March 12 1995 / CENTENNIAL STATION / 100 YEARS OF SERVICE / POSTMASTER / CORY, CO 81418-9998



March 12 1995
CENTENNIAL STATION
100 YEARS OF SERVICE
POSTMASTER
CORY, CO 81418-9998

CRAWFORD

Crawford was established in 1882 as a community to serve agriculture in the southeastern portion of Delta County and portions of Montrose County north of the Gunnison River and the Black Canyon of the Gunnison. The town continues to serve that purpose. With the creation of the Black Canyon of the Gunnison National Park and the development of visitor facilities on the north side of the canyon, Crawford has avoided the significant declines in population and activity that have struck many of the smaller communities in this area of Colorado.

Development of the town is credited to George Crawford, a frontier capitalist, speculator and former governor of Kansas. Crawford was a prominent figure of the western slope during the 1880's and is also credited with helping to found Grand Junction and Delta. The name of the town honors Crawford's contribution to its development.

The initial Post Office Department Geographic Site Location Report dated March 23, 1883, for Crawford raises an intriguing question. The report indicates that initially the desired name for this new post office was Leon. That entry was crossed out and Crawford was substituted. There is also a Geographic Site Location Report for a Leon in Mesa County. That report is dated March 20, 1883 – three days earlier. The locations and persons mentioned on these two reports are different. But, is it possible that there may have been more than coincidence in the names?

There is no difficulty in finding Crawford. From Delta, drive east on Colorado Highway 92 to Hotchkiss and stay on that road after its intersection with Colorado 133. From Hotchkiss, for most of the distance the road goes southeast or south, but about three miles from Crawford the road swings due east for a mile and a half before once again turning southeast, a mile from Crawford. The first location for Crawford, according to the Geographic Site Location Reports was just west of this final turn to the southeast. Today there is nothing to indicate that this was more than an interim location before the community was firmly established on the Smith Fork of the Gunnison.



CRAWFORD, / COLO. July 22, 1896 with 16-bar oval grid

CRAWFORD – Continued

Latitude = 38:42:14 North Longitude = 107:36:30 West

Chronology of the Post Office

Mar 23 1883	---	Land not surveyed On the north side of the Smith Fork Proposed postmaster - Joel F. Preston	
Apr 14, 1883		Established	
Apr 13 1883		Preston, Joel S.	
Nov 25 1884		Grant, Henry	
Jan 23 1886	---	NW/4 Sec 36 T15S R92W 1 mile northwest of the Smith Fork River	
Jun 7 1888		Morrow, Alexander W.	
Apr 6 1892		Ong, Eliza S.	
Dec 11 1899		Zimmerman, Floyd D.	
Aug 2 1901		Foster, Elsie L.	
Jan 29 1902		Graham, Ursen H.	
Sep 1 1905		Hendricks, George W.	
Feb 15 1910		Gould, Willard D.	
Feb 25 1914	---	SW/4 Sec 31 T15S R91W 1/4 mile north of Smith Creek	
Apr 27 1914		Hopkins, William	
May 15 1919		Simmins, Willis C.	
Jan 1 1921			Office made Presidential
Jul 17 1922		Wood, Will J.	Acting
Jul 2 1926		Wood, Will J.	Appointed
Jul 23 1927		Hopkins, William	Acting
Aug 23 1927		Wood, May J.	Acting
Jan 27 1928		Wood, May J.	Appointed
Feb 01 1932		Wood, May J.	Nominated
Feb 17 1932		Wood, May J.	Confirmed
Apr 02 1932		Wood, May J.	Commissioned
Mar 16 1936		Van Engen, Will	Nominated
Mar 27 1936		Van Engen, Will	Confirmed
Apr 1 1936		Van Engen, Will	Appointed Presidential
Apr 18 1936		Van Engen, Will	Commissioned
Apr 30 1936		Van Engen, Will	Assumed charge
May 1 1936		Van Engen, Will	Assumed charge
Apr 15 1940		Van Engen, Will	Nominated
Apr 24 1940		Van Engen, Will	Confirmed
Apr 29 1940		Van Engen, Will	Appointed Presidential
May 14 1940		Van Engen, Will	Commissioned
Jun 1 1940		Van Engen, Will	Assumed charge
Oct 25 1941	---	SW/4 Sec 31 T15S R91W 1/4 mile north of Smith Fork Creek	
May 6 1966		Van Engen, Kathryn D.	Acting
Oct 7 1966		Howell, Myrtle D.	Acting
Apr 4 1968		Wilkening, Clifford	Nominated & Appointed
Apr 17 1968		Wilkening, Clifford	Commissioned
May 3 1968		Wilkening, Clifford	Assumed charge

Confirmed types of postal markings

1	CRAWFORD, / COLO. CI 10P 29.0	Apr 5 1894 Jul 22 1896
2	CRAWFORD / COLO. CI 10P 27.5	Dplx Grid 16 bar oval Feb 2 1892 Oct 18 1898
3	CRAWFORD, / COLO. CI 10P 32.0	Hstp Target 17mm Jun 18 1912 Sep 6 1916
3.0.1	CRAWFORD, / COLO. RC 10P 36.0x14.0	4bars S-??x20mm 1920s Hstp No killer, Parcel Post Box

CRAWFORD – Continued

3.1	CRAWFORD / COLO. CI 10P 30.0	Jan 6 1932
		Dplx Grid, 9-bar oval
4	CRAWFORD / COLO CI 10P 33.0	Feb 4 1933 Aug 10 1934
5	CRAWFORD, COLO. CI 10H 31.0	Apr 12 1937 Jun 15 1938
6	CRAWFORD / COLO. CI 10P 30.0	Nov 14 1938 Apr 1 1953
		Dplx Grid, diamond with 1
7	CRAWFORD, CO / 81415 CI 10P 31.0	Jun 23 1967 Apr 30 1977
7.1	CRAWFORD, CO / 81415 CI 10P 33.5	Aug 8 1980 Dec 7 1985
7.2	CRAWFORD, CO / 81415 CI 10P 23.0	May 29 1990 May 15 1991
		Mach 7 wavy lines
8	CRAWFORD, CO / 81415 CI 10P 30.0	Feb 24 1987 Jun 3 1991
		4bars S-23x18mm

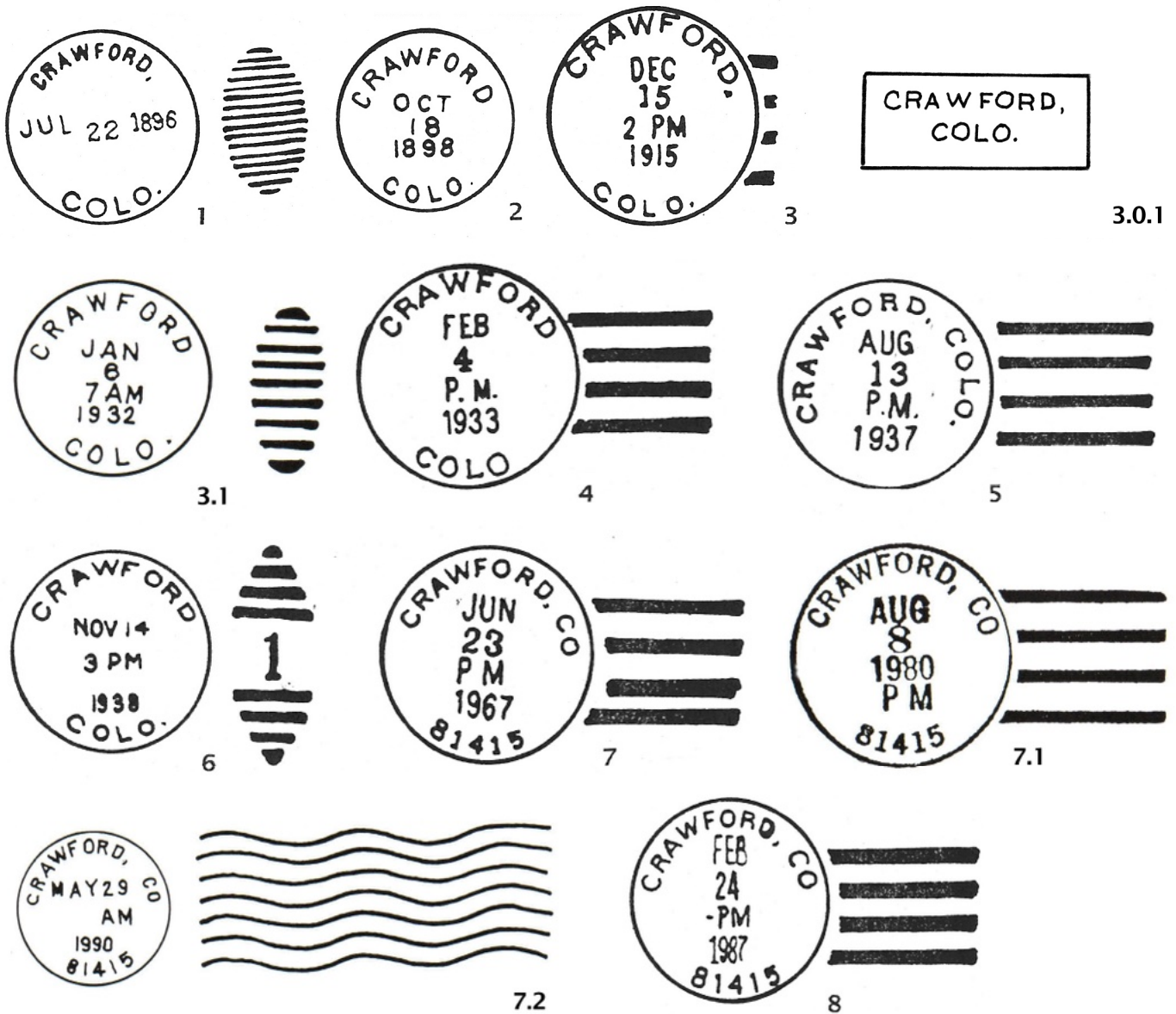

DELTA

Shortly after the Ute Indians were relocated to Utah, George A. Crawford, the founder of Grand Junction, purchased the squatter rights of W. O. Stephens to a tract of land at the junction of the Uncompahgre and Gunnison Rivers. On October 1, 1881 The Uncompahgre Town Company, consisting of George A. Crawford, M. C. Vandeventer and a Mr. Anderson selected and had surveyed a town site to be named Uncompahgre. In December 1881 an application for a post office was filed. However, there was already an Uncompahgre Post Office, not only in Colorado, but also in the same county - Gunnison County at that time. Therefore the name Delta was chosen, being drawn from the townsite's location on the fertile delta formed by the junction of the two rivers.

Growth of the community of Delta was slow until 1883 when two events provided it with a solid foundation for the future. With the formation of Delta County on February 11, 1883, Delta was chosen to be the county seat. In the same year, The Denver and Rio Grande Railroad entered Delta as its construction progressed west towards Grand Junction.

For its prosperity, Delta has relied on no single industry. It is located in the center of a fertile agricultural region, which has developed into a diversified farming and ranching area. Delta also became the principal supply, trading and shipping point for a large area lying between Montrose and Grand Junction. In recent years, its moderate climate has attracted light industry to this portion of the Gunnison Valley. Delta is a well developed, modern community, located on US Highway 50 with a rail connection to Grand Junction.

Latitude = 38:44:32 North Longitude = 108:04:06 West

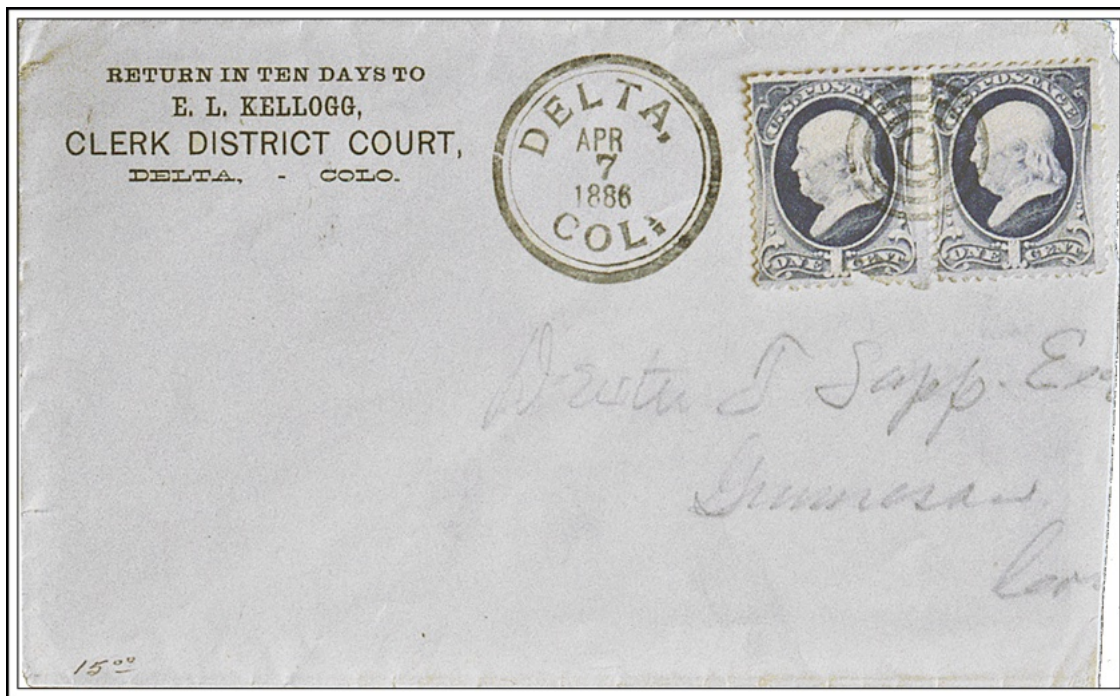

DELTA, / COL. April 7, 1886

Chronology of the Post Office

Dec 20 1881	---	Not surveyed 1/2 mile south of the Gunnison River, 1/2 mile east of the Uncompahgre River Proposed postmaster - Francis M. Anderson
Jan 5 1882		Established
Jan 5 1882		Anderson, Frances M.

DELTA – Continued

May 14 1883	Standish, Otis T.	
Dec 2 1885	Brown, Warren D.	
May 11 1889	Stephens, William O.	
Jan 9 1891	Stephens, William O.	P&S
Jan 15 1895	Simpson, W. Roy	P&S
Dec 20 1898	Stephens, William O.	P&S
Mar 20 1900	Chrysler, Charles B.	P&S
Apr 12 1904	New, Ella	P&S
May 22 1908	New, Ella	P&S
Jun 17 1912	New, Ella	P&S
Mar 3 1914 ---	SE/4 Sec 13 T15S R96W	
Jun 2 1916	Geer, Taylor B.	P&S
Feb 10 1922	Smith, Clarence A.	P&S
Mar 2 1926	Smith, Clarence A.	P&S
Mar 8 1930	Smith, Clarence A.	P&S
May 29 1934	Ellington, Glenn G.	Nominated
Jun 6 1934	Ellington, Glenn G.	Appointed & Confirmed
Jun 28 1934	Ellington, Glenn G.	Commissioned
Apr 29 1938	Ellington, Glenn G.	Nominated
May 3 1938	Ellington, Glenn G.	Confirmed
Jun 6 1938	Ellington, Glenn G.	Appointed Presidential
Jun 8 1938	Ellington, Glenn G.	Commissioned
Mar 16 1939 ---	Fourth & Meeker Streets	A move 400 feet northeast of previous location
Oct 28 1941 ---	SE/4 Sec 13 T15S R96W	SW corner 4th & Meeker Streets
Oct 2 1942	Ellington, Glenn G.	Nominated
Dec 4 1942	Ellington, Glenn G.	Confirmed
Dec 7 1942	Ellington, Glenn G.	Appointed Presidential
Dec 26 1942	Ellington, Glenn G.	Commissioned
Dec 31 1942	Ellington, Glenn G.	Assumed charge
Jun 30 1952	Dale, Willis	Acting & Assumed charge
Jul 24 1952	Dale, Willis	Acting
Dec 31 1953	Moeller, Gilbert H.	Acting
Apr 14 1954	Moeller, Gilbert H.	Nominated
May 24 1954	Moeller, Gilbert H.	Apptd Presidential, Confirmed & Commissioned
Jun 30 1954	Moeller, Gilbert H.	Assumed charge
Apr 27 1973	Webb, Harold C.	Officer in charge
Jun 30 1973	Webb, Harold C.	Appointed
Apr 22 1978	Graham, Nancy M.	Officer in charge
Oct 19 1978	Dobbs, David E.	Officer in charge
Mar 24 1979	Manzanares, Vicente I.	Appointed

Confirmed types of postal markings

1	DELTA, / COLORADO CI 21H 32.0/28.0/17.0	Jan 11 1883 Jun 3 1883 [or Jun 9 as traced?]
1.1	Delta Col MS	Hstp Fancy, Maltese Cross Jul 7 1883
2	DELTA, / COLO. CI 21P 28.0/26.0/17.0	Msep Pen cancel Dec 24 1883 Aug 22 1885
3	DELTA, / COL. CI 20H 29.0/24.0	Hstp Grid, 10-bar circular Apr 7 1886 Apr 26 1890
4	DELTA / COLO. CI 10P 27.0	Hstp Target, 4-ring 18mm Jun 17 1891 Oct 19 1894
5	DELTA / COLO. REC'D. CI 10P 28.0	Hstp Cork, 3-bar circular grid; smudge Aug 13 1895
		Hstp No killer, backstamp [NOT AVAILABLE FOR ILLUSTRATION]

DELTA – Continued

6	DELTA / COLO. CI 10P 28.0	Oct 10 1898 Sep 19 1899 Hstp Fancy, Positive star; Cork, Negative X-roads, smudge
7	DELTA / COLO. CI 10P 30.0	May 30 1902 Jun 16 1910 Dplx Grid, 9 bar oval
8	DELTA / COLO. CI 10P 25.0	Feb 15 1911 Feb 26 1915 Dplx Grid, oval with 1 and circle
9	DELTA / COLO. CI 10P 25.5	Aug 8 1919 Sep 18 1936 Dplx Grid, oval with 1 and circle
10	DELTA, COLO. CI 10P 23.0	Mar 15 1926 Mar 29 1927 Flag 13 star waving flag
11	DELTA, / COLO. CI 10P 20.5	May 25 1930 Mar 22 1962 Mach 7 wavy lines
12	DELTA, COLO. / REC'D. CI 10P 30.0	Aug 17 1936 Hstp No Killer
13	DELTA / COLO. CI 10P 30.5	Oct 23 1941 Oct 5 1955 Dplx Grid, oval with 1
14	DELTA, COLO. / ??? CI 11P 30.0/19.0	Oct 30 1946 Hstp No killer; Something appears to have been cut from the bottom portion of the dial
15	DELTA / COLO. CI 11P 27.0/18.0	Oct 13 1954 Hstp No killer
15.1	DELTA, / COLO. RC 10P 37.0x19.0	1950s Hstp No killer, Parcel Post Box
15.2	DELTA, COLO. CI 11P 35.0/27.0	Apr 3 1959 Hstp No killer
16	DELTA / COLO. CI 10P 20.5	Jan 23 1963 Dec 24 1964 Mach 6 wavy lines
17	DELTA / COLO. CI 10P 20.5	Oct 28 1965 Mach Slogan: Smokey Bear and, Remember / Only you can / PREVENT / FOREST FIRES
18	DELTA / COLO. CI 11P 30.0/20.0	May 12 1967 Hstp No killer
19	DELTA, / COLO. RC 10P 49.0x16.0	May 12 1967 Hstp No killer, Parcel Post Box style
19.1	DELTA, CO / 81416 CI 10P 20.5	Oct 14 1968 May 18 1969 Mach 6 wavy lines
20	DELTA, CO / 81416 CI 10P 32.0	Jan 2 1968 Dec 11 1975 4bars S-24x20mm
21	DELTA, CO / 81416 CI 10P 20.5	Mar 1 1982 Aug 14 1982 Mach Slogan in box with bars: CITY OF DELTA, CO / 100TH ANNIVERSARY / 1882 -- 1982
22	DELTA, CO / USPO CI 11P 29.0/19.0	Jan 12 1984 Apr 13 1987 Hstp No killer
22.1	DELTA CO / 81416 CI 11P 32.0	Dec 19 1989 4bars S-21x15mm
23	DELTA, CO 81416 / USPS CI 11P 29.0/20.0	Apr 16 1990 Apr 14 1993 Hstp No killer

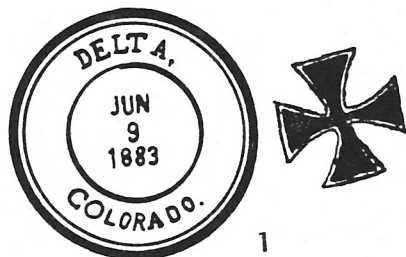

1

*Delta Col
July 7th
1883*

1.1



2

DELTA - Continued



3



4



6



7



13



8



1919



9



10

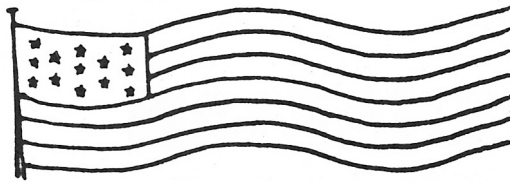

11

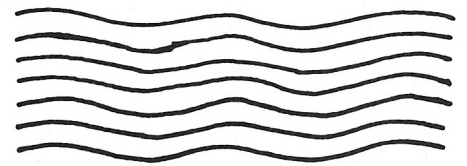

12



13

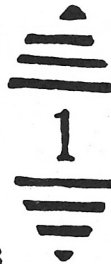

14



15

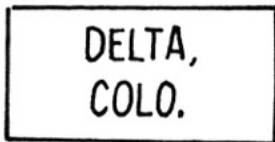

15.1



15.2



16



17



18



19

DELTA – Continued



19.1

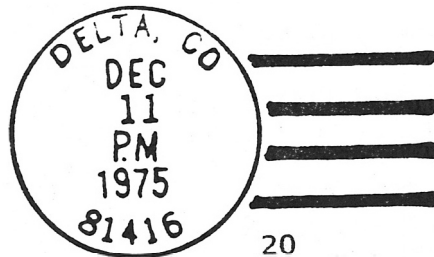
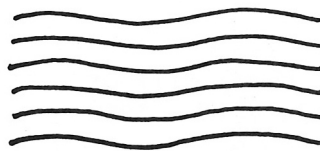

20



21



22

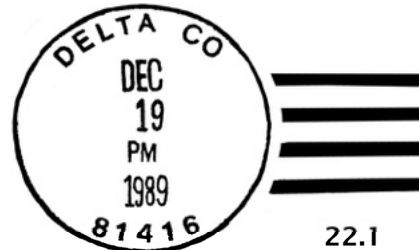

22.1



23

AUXILIARY MARKINGS

A-1 MISSENT TO / DELTA, COLO.
SL 00R 27.0x9.0

Sep 19 1911

Hstp; Note Fancy "C";
On postcard from Cedaredge to Eckert Colo.

MISSENT TO
DELTA, COLO. A 1

DELTA STATIONS

CELEBRATE THE CENTURY STATION

Chronology of the Post Office

Jun 9 2000 Operated as a Special Commemorative Station

Confirmed types of postal markings

1 Delta, CO 81416 // Celebrate the Century Station Jun 9 2000
SL 00R 92.0x3.0 Pict Text only - CENTENARIAN / -- 100 -- /
The Life of a Century

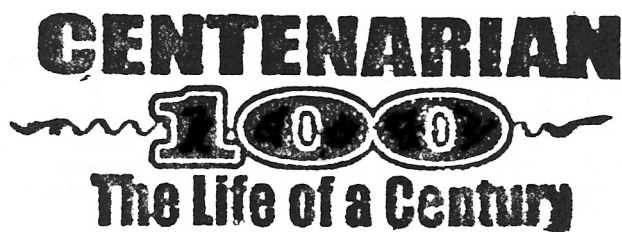

June 9, 2000 - Celebrate the Century Station Delta, CO 81416

DELTA STATIONS – Continued

10TH ANNUAL COUNCIL TREE POW WOW STATION

Chronology of the Post Office

Sep 18 2004 Operated as a Special Commemorative Station

Confirmed types of postal markings

- 1 Delta, Colorado 81416 // 10th Annual Council Tree Pow Wow Sta. Sep 18 2004
IR 00R 74.0x37.0 Pict Scene - Tree, feather; No additional text

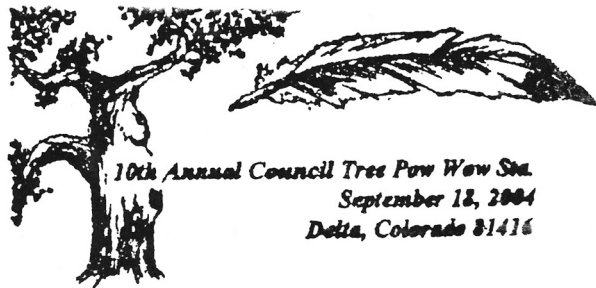

1

THUNDER MOUNTAIN STATION

Chronology of the Post Office

Jun 6 1986 Operated as a Special Commemorative Station

Confirmed types of postal markings

- 1 DELTA, COLORADO 81416 // THUNDER MOUNTAIN STATION Jun 6 1986
IR 00R 100.0x46.0 Pict Oval scene, mountain profile and lightning bolt

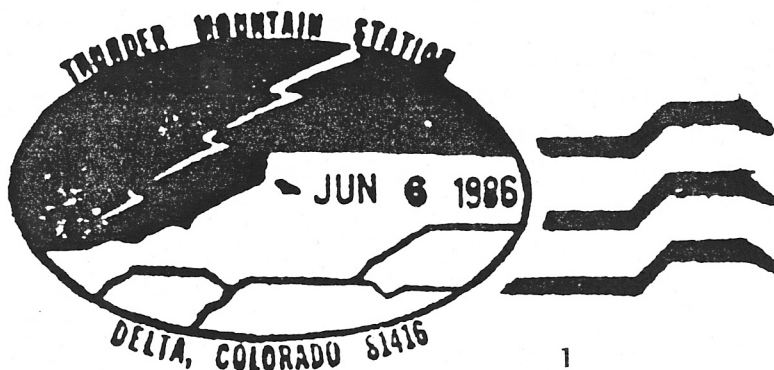

1

DOMINGUEZ

Dominguez was a station on the Denver and Rio Grande Railroad approximately 15 miles west-northwest of Delta. In this area, the Gunnison River has incised a canyon some 500 feet in depth. The name of the station and settlement commemorates Fray Atanasio Dominguez, member of a 1776 Spanish expedition through what is now western Colorado. The Hayden Survey of the 1870's honored the leaders of that expedition with the naming of Dominguez and Escalante Creeks.

Fruit growing is a principal activity in this portion of the Gunnison Canyon. It is unlikely that Dominguez was ever more than a railroad station, siding and a group of ranch buildings. The post office would have served other ranches and farms along this portion of the Gunnison River.

DOMINGUEZ – Continued

From Delta, drive west on US 50 about eleven miles to County Road J50. This is a dead end gravel road that goes from the highway down to the river. Near the foot of the grade is an intersection marked by a group of mailboxes. Now begins some confusion. Take the left-hand branch of this fork. The right hand fork leads only to an overlook. It is a half-mile more to a Y intersection.

**DOMINGUEZ, / COLO.****June 6, 1908**

The United States Geological Survey maps label this intersection as Dominguez. In 2000 there was nothing to be found at this location. However, the Post Office Department Geographic Site Location Report for Dominguez locates the post office a little more than a mile up the right-hand fork of this Y. That location is labeled as Broughton on the USGS maps. At that point there is a large orchard and ranch with several buildings. One of the buildings is close to the railroad and is probably a warehouse for shipping. It could have been a railroad station to serve the farmers along this portion of the river. It is an attractive setting and in spite of the USGS maps, I favor this as the location for Dominguez. The notation in the Site Location Report that, “(Dominguez Signal station was two miles southeast)” supports this.

Latitude = 38:47:50 North Longitude = 108:19:18 West

Chronology of the Post Office

May 7 1907	---	SE/4 Sec 22 T14S R98W D&RG 100 feet east of office Dominguez Signal Station two miles southeast Gunnison River 300 feet west of office
Aug 17 1907		Established
Aug 17 1907		Roberts, Martha J.
Jan 9 1911		Leonard, Alden
Aug 14 1912		Storts, John C.
Oct 31 1913		Discontinued

DOMINGUEZ – Continued

Confirmed types of postal markings

- | | | | |
|---|-----------------------------------|-----------------|------------------------------------|
| 1 | DOMINGUEZ, / COLO.
CI 10P 32.0 | 4bars S-23x14mm | Jun 6 1908 Jan 6 1910 |
| 2 | DOMINGUZ, / COLO.
CI 10P 32.0 | 4bars S-25x21mm | Feb 24 1913
[ERROR IN SPELLING] |

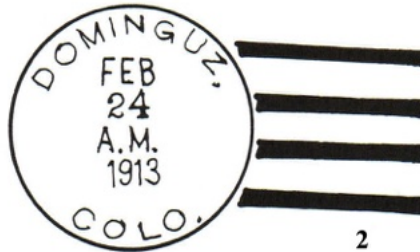
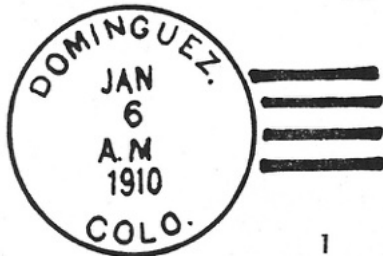

ECKERT

Eckert is another of the small communities that lie within the boundaries of Orchard City, along Colorado Highway 65 on the way to Grand Mesa.

The name of the community, Eckert, is the maiden name of Elizabeth States, wife of the first postmaster, Adelbert States. There is some confusion regarding this postmaster's name. On the original Geographic Site Location Report, it appears to be Slater. I have also seen references that spell it as Slates but the majority opinion favors States. The post office was initially located in the store operated by Mr. States.

On my 1972 visit to Eckert, and still in 2000, the post office was in a brick structure in front of, and attached to a residence on the east side of Highway 65. It is across the street from the Presbyterian Church.

Eckert is a small community of several homes, an old school and a Presbyterian Church. It is a more compact community than either Austin or Cory.

Like Austin and Cory, Eckert's economy was and is based on agriculture in the surrounding countryside.

Eckert is about four miles from Cory to the south and Cedaredge to the north.

Latitude = 38:50:34 North Longitude = 107:57:44 West

Chronology of the Post Office

- | | | | |
|-------------|-----|--|--------------------------|
| Sep 28 1891 | --- | NE/4 NW/4 Sec 13 T14S R95W 1/8 mile east of Surface Creek
Proposed postmaster - Charles A. Slater | |
| Oct 27 1891 | | Established | |
| Oct 27 1891 | | States, Charles A. | |
| Dec 2 1891 | | Reavis, David C. | |
| May 6 1892 | | Nowlin, James F. | |
| July 5 1892 | --- | NE/4 NE/4 Sec 14 T14S R95W 75 yards east of Surface Creek | |
| Oct 26 1892 | | States, Charles A. | |
| May 16 1895 | | Reynolds, Abraham L. | |
| Feb 16 1901 | | Chambers, Bessie M. | |
| Apr 11 1906 | | Wenger, Elias | |
| Mar 7 1914 | --- | NW/4 Sec 13 T14S R95W 20 rods east of Surface Creek | |
| Sep 10 1914 | | Wenger, Hattie M. | |
| Sep 24 1918 | | Smith, Echo M. | |
| Apr 1 1923 | | | Office made Presidential |
| Oct 23 1923 | | Wenger, Elias | Acting |

ECKERT – Continued

Feb 8 1924	Wenger, Elias	Appointed
Jul 1 1926		Relegated
Jul 3 1926	Wenger, Elias	Appointed
Jan 31 1940	Pollock, Mrs. Dorothy L.	Acting
Feb 1 1940	Pollock, Mrs. Dorothy L.	Assumed charge
Feb 14 1940	Pollock, Mrs. Dorothy L.	Acting
Aug 20 1940	Pollock, Mrs. Dorothy L.	Appointed & Confirmed
Oct 11 1940	Pollock, Mrs. Dorothy L.	Commissioned
Oct 31 1940	Pollock, Mrs. Dorothy L.	Assumed charge
Jul 1 1945		Office made Presidential
Sep 26 1945	Pollock, Mrs. Dorothy L.	Nominated
Oct 29 1945	Pollock, Mrs. Dorothy L.	Confirmed
Oct 30 1945	Pollock, Mrs. Dorothy L.	Appointed Presidential & Commissioned
Mar 31 1946	Pollock, Mrs. Dorothy L.	Appointed
May 20 1946	Jones, Dorothy L.	Name changed by marriage
Jan 9 1948 ---	NW/4 Sec 13 T14S R95W A move 85 feet north of previous location 120 yards east of Surface Creek	
Feb 15 1968	Smith, Dorothy L.	Name changed by divorce
Jun 4 1976	Morman, Ms Charlen	Officer in charge
Mar 11 1978	Morman, Mrs. Charlene F.	Appointed
Mar 10 1980	Perkins, Nona M.	Officer in charge
Jul 12 1980	Perkins, Mrs. Nona M.	Appointed

Confirmed types of postal markings

1	ECKERT / COLO. CI 10P 28.0	Hstp Target	Nov 11 1897
2	ECKERT / COLO. CI 10P 27.5	Hstp Cork, smudge	Jul 15 1908 Jan -- 1910
3	ECKERT, / COLO. CI 10P 32.0	4bars S-??x19mm	Dec 22 1913 Sep 10 1919
3.1	ECKERT, / COLO. CI 10P 32.0	4bars S-24x19mm	May 13 1915
4	ECKERT, COLO. CI 11P 30.0/20.0	Hstp Not present	Oct 25 1933
5	ECKERT, / COLO. CI 10P 33.5	4bars S-25x20mm	Aug 19 1935 Jun 21 1940
6	ECKERT / COLO. CI 10P 32.0	4bars S-23x20mm	Jul 20 1940 Oct 4 1949
7	ECKERT / COLO. CI 10P 30.0	Dplx Grid, diamond with 1	Dec 8 1952 Aug 8 1957
7.1	ECKERT, / COLO. RC 10P 36.0x19.0	Hstp No killer, Parcel Post Box	1950s
8	ECKERT / COLO. CI 10P 33.0	4bars S-??x20mm	May 1 1964
9	ECKERT, CO / 81418 CI 10P 33.0	4bars S-25x20mm	Apr 1 1967 Dec 12 1989
9.1	ECKERT, CO / 81418 CI 10P 20.0	Mach 7 wavy lines	Sep 28 1985
9.2	ECKERT, CO / 81418 CI 10P 20.0	Mach 7 wavy lines	May 10 1993
10	ECKERT CO 81418 / USPS CI 10P 35.0	4bars S-11x22mm	Sep 22 2000

ECKERT – Continued

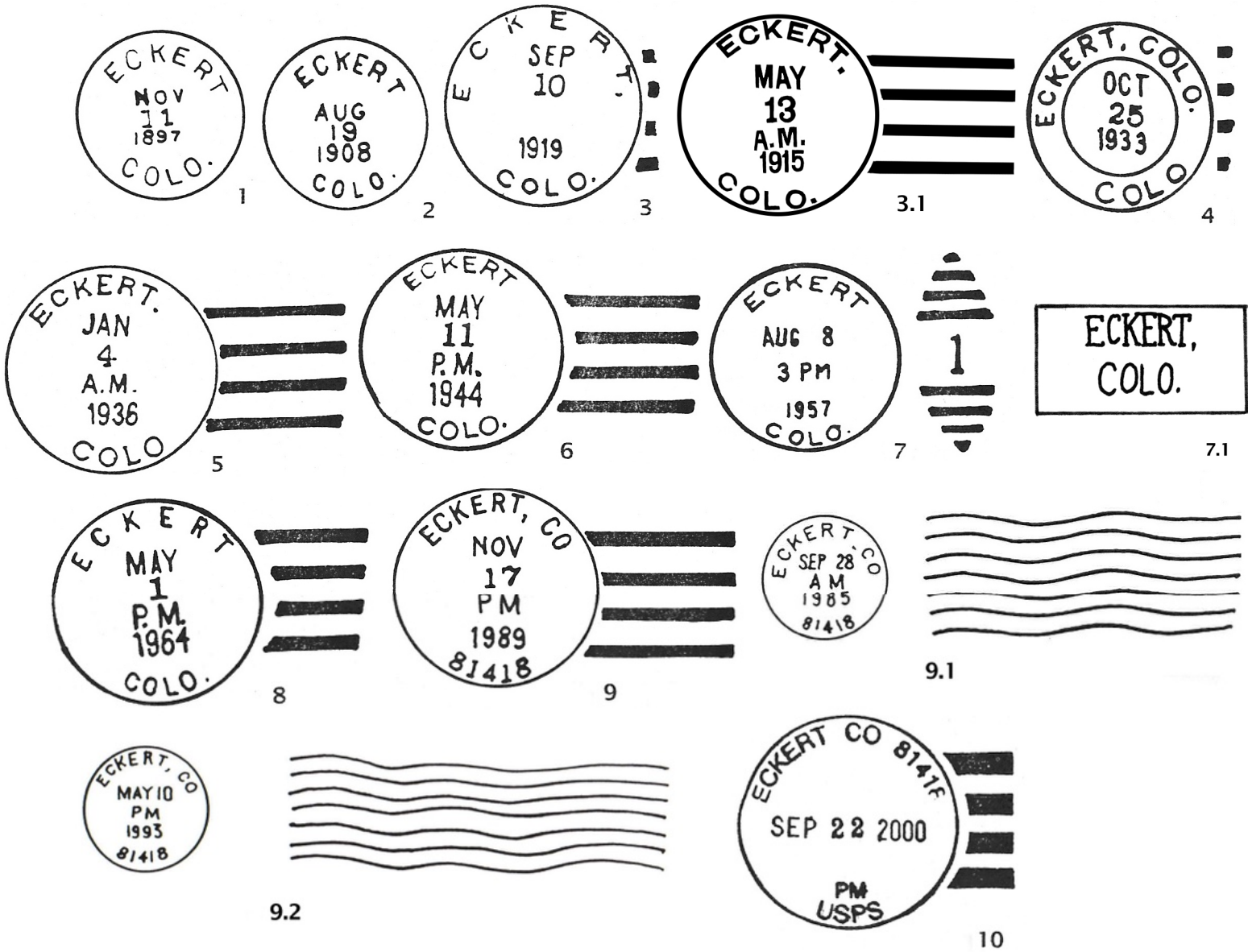

CELEBRATE THE CENTURY STATION

Chronology of the Post Office

Jun 15 2000 Operated as a Special Commemorative Station

Confirmed types of postal markings

- 1 Eckert, CO 81418 // Celebrate the Century Station Jun 15 2000
SL 00R 59.0x1.5 Pict Text only - CENTENARIAN / -- 100 -- /
The Life of a Century

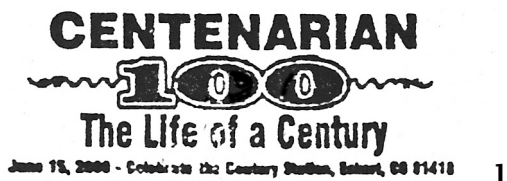

ESCALANTE

This settlement was located at the mouth of Escalante Creek where it joins the Gunnison River. It is recorded as a “Denver and Rio Grande stop near the confluence of Escalante Creek and the Gunnison River.”

It was named for Father Francisco Silvestre Velez Escalante, another of the principals in the 1776 Spanish exploration of what is now western Colorado. If indeed this was a railroad stop, it is likely that it was little more than a siding and a depot for use of ranchers and farmers along this portion of the Gunnison River.

Although Escalante appears in the Records of Postmaster Appointments, those records indicate that Charles Blair, the appointed postmaster, declined the appointment and subsequently the establishment was rescinded.

As with Dominguez, the site of Escalante is reached by driving down into the Gunnison Canyon from US Highway 50. I suspect that I did not visit the correct location. Using the entrance to the Delta County Correctional Facility as a marker, continue west on US 50 4.3 miles.

The road I chose to take is on the left side and is just after you exit a road cut and before you cross a drainage. This is not a county road and maintenance is poor. The road brings you down to the river and turns to the southeast or upstream. About a mile further the road peters out at a point where there is evidence for some type of building having been present.

I now suspect that Escalante was about a mile downstream from where the above-described road reached the river. From maps, this is where Escalante was more likely located. Indications are that by going west a mile further on US 50, there is a county road, which goes into the canyon, crosses the river and continues southwest up Escalante Creek. This will be investigated when I am on a future trip to visit the site of the Escalante Forks Post Office in Mesa County.

ADDITIONAL INFORMATION

The following was included in *High Country Wanderings*, Volume 19, Number 1.

In the spring, Jim Ozment and I once again set off for the Western Slope. It was a catch-up tour, to visit several sites that for one reason or another we had passed on during previous trips. Included were two places in Delta County, Roubideau and Escalante, for which my information had been in error. In the case of Escalante, I simply went down the wrong road. Roubideau is still a puzzle. The Post Office Department location is several miles east of Delta but the true location is a few miles west of Delta. My only explanation is that there was a change in the Federal Land Survey subsequent to the original report.

To reach what is likely the site for the proposed Escalante Post Office, turn west from US Highway 50 onto the road to Escalante Canyon. This is about 10 miles west of Delta. In 2003 there was a small rest stop at that intersection. Follow the road to the bridge over the Gunnison River. Escalante was somewhere in this area. Perhaps at a siding on the east side of the river or perhaps at the ranch complex on the west side. This road continues on to Escalante Forks in Mesa County, 24 miles from US Highway 50.

Chronology of the Post Office

Sep 9 1903	Established
Sep 9 1903	Blair, Charles B.
Dec 5 1903	Establishment rescinded Postmaster declined appointment

Confirmed types of postal markings

NO POSTAL MARKINGS HAVE BEEN REPORTED FROM ESCALANTE

GRAND MESA

The Grand Mesa Post Office was at a location on top of the mesa itself, within the boundaries of the Grand Mesa National Forest and at an elevation in excess of 10,000 feet. After reaching the top of the Mesa via Colorado Highway 65 from Cedaredge, you enter an area of small lakes and reservoirs. The visitor's center is opposite the east end of Island Lake. The road that leads to the visitor center continues on approximately a mile and a half to Hotel Lake (and beyond). On the east side of the small stream that drains from Hotel Lake is the well-maintained Alexander Lake Lodge. Beyond the lodge are a number of cabins along the road and on the edge of Baron Lake. Hotel Lake is also ringed with cabins and there is a recreational vehicle park. The Alexander Lake Lodge appears to have been in existence for a considerable period of time. It is a likely place for the Grand Mesa Post Office to have been located and this is in general agreement with the specifications in the 1941 Geographic Site Location Report.

At least from 1954 until the final closing at the end of August 1958, the Grand Mesa Post Office was a summer operation only: from mid-June until mid-September. Since this area was a resort community, I suspect that the summer operation schedule was in effect prior to 1954 and perhaps throughout the life of this office.

Latitude = 39:02:25 North Longitude = 107:56:57 West

Chronology of the Post Office

Apr 11 1927	---	Sec 1 T12S R95W Applicant for postmaster - John C. Gale	
Jun 23 1927		Established	
Jun 23 1927		Gale, John C.	
Mar 11 1931		Cannon, Garfield	Possession
Apr 6 1931		Cannon, Garfield	Acting
May 6 1931		Cannon, Garfield	Appointed & Confirmed
May 27 1931		Cannon, Garfield	Commissioned
May 19 1934		Wear, George F.	Confirmed
Jun 15 1934		Wear, George F.	Assumed charge
Jun 16 1934		Wear, George F.	Acting
Jul 20 1934		Wear, George F.	Commissioned
Feb 19 1941		Wilcox, Theodore R.	Assumed charge
Feb 25 1941		Wilcox, Theodore R.	Acting
Apr 4 1941		Wilcox, Theodore R.	Confirmed
May 23 1941		Wilcox, Theodore R.	Commissioned
Oct 23 1941	---	NW/4 Sec 1 T12S R95W Alexander Lake south 1/4 mile Twin Lake north 100 yards from post office	
Jun 14 1945		Thomas, Charles E.	Assumed charge
Jun 20 1946		Hawker, Mrs. Winifred A.	Confirmed
Aug 6 1946		Hawker, Mrs. Winifred A.	Commissioned
Aug 28 1946		Hawker, Mrs. Winifred A.	Assumed charge
Sep 7 1946		Anderson, Mrs. Winifred A.	Name changed by marriage
Jul 15 1947		Randall, Mrs. Esther L.	Assumed charge
Nov 3 1947		Randall, Mrs. Esther L.	Confirmed
Feb 9 1948		Randall, Mrs. Esther L.	Commissioned
Jun 18 1951		Erickson, Mrs. Vedra V.	Assumed charge
Jul 1 1951		Erickson, Mrs. Vedra V.	Acting
Aug 23 1951		Erickson, Mrs. Vedra V.	Confirmed
Sep 20 1951		Erickson, Mrs. Vedra V.	Commissioned
Jun 15 1955		Williams, S. Monedith	Assumed charge
Jul 1 1955		Williams, S. Monedith	Acting
Aug 12 1955		Williams, S. Monedith	Confirmed
Sep 15 1955		Williams, S. Monedith	Commissioned
Aug 31 1958		Discontinued	

GRAND MESA – Continued

Confirmed types of postal markings

1	GRAND MESA, / COLO. CI 10P 32.0	4bars S-24x19mm	Aug 17 1938 Aug 10 1943
2	GRAND MESA / COLO. CI 10P 32.0	4bars S-22x18mm	Aug 22 1947 Aug 31 1958
3	GRAND MESA / COLO. CI 11P 29.0/19.0	Hstp No killer	Aug 31 1958

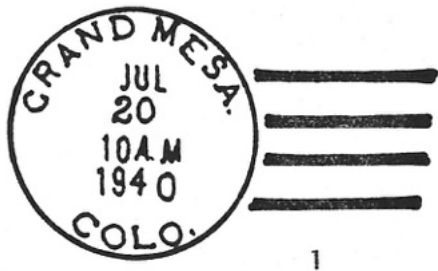

Alexander Lake Lodge at Grand Mesa, Colorado

Photograph by William H. Bauer

September 22, 2000

HOTCHKISS

Hotchkiss was founded in 1881 and has become one of the principal towns on the North Fork of the Gunnison River. Enos Hotchkiss was one of the earliest settlers, establishing himself even before the Ute Indians had been removed from the area. The town was named for Enos. Hotchkiss was incorporated March 14, 1901.

HOTCHKISS – Continued

Since its founding, Hotchkiss has been a community that depended on agriculture and ranching for its economic base. With the development of a fruit growing industry along the North Fork, Hotchkiss became a center for that activity. In addition to agriculture, coal mining along the North Fork has also contributed to the economic health of Hotchkiss.

Hotchkiss has an active business district that serves the surrounding area. The growth of Hotchkiss and the fruit industry was substantially boosted by the construction of a branch line of the Denver and Rio Grande Railroad through the valley. The railroad reached Hotchkiss on September 18, 1902.

Hotchkiss is on Colorado Highway 92 at the junction with Colorado 133, the road to McClure Pass and Glenwood Springs.

Since at least 1972 the post office has occupied a brick building on the north side of the main street (Colorado 92).

Latitude = 38:47:59 North Longitude = 107:43:08 West

Chronology of the Post Office

Sep 20 1882	---	Late, Ute Indian Reserve 1/4 mile northwest of North Fork of Gunnison River On the east side of Leroux Creek Proposed postmaster - George A. Duke	
Oct 3 1882		Established	
Oct 3 1882		Duke, George H.	
Dec 23 1885		McDougal, William A.	
Dec 29 1886		Duke, William F.	
May 16 1889		Duke, George H.	
May 16 1894		Gelwicks, Luther C.	
Apr 8 1898		Galliher, James W.	
Oct 19 1903		Muller, George W.	P&S
Mar 8 1904	---	SE/4 SW/4 Sec 31 T14S R92W North side North Fork of Gunnison 1/2 mile east of Leroux Creek	
Jan 22 1908		Muller, George W.	P&S
Jun 8 1911		Field, Jesse E.	P&S
Mar 19 1914	---	SW/4 Sec 30 T14S R92W About 3/4 mile east of Leroux Creek	
May 29 1915		Sanderson, Fred H.	Presidential
Dec 16 1915		Sanderson, Fred H.	P&S
Mar 2 1920		Sanderson, Fred H.	P&S
Apr 7 1924		Klingensmith, Maude E.	P&S
Mar 7 1926		Whitney, Robert	Acting
Jun 22 1926		Arthur L. Perry	
May 29 1930		Arthur L. Perry	
Jul 10 1934		Neill, Charles R.	Acting
Jul 17 1934		Neill, Charles R.	Assumed charge
Aug 16 1935		Duke, George H. Jr.	Nominated
Aug 21 1935		Duke, George H. Jr.	Confirmed
Aug 27 1935		Duke, George H. Jr.	Appointed Presidential
Sep 18 1935		Duke, George H. Jr.	Commissioned
Sep 23 1935		Duke, George H. Jr.	Assumed charge
Aug 2 1939		Duke, George H. Jr.	Nominated
Aug 4 1939		Duke, George H. Jr.	Confirmed
Aug 27 1939		Duke, George H. Jr.	Appointed Presidential
Oct 20 1939		Duke, George H. Jr.	Commissioned
Oct 31 1939		Duke, George H. Jr.	Assumed charge
Oct 22 1941	---	SW/4 Sec 30 T14S R92W North Fork of Gunnison River .5 miles from office	
Nov 17 1958		Clay, Neil K.	Assumed charge

HOTCHKISS – Continued

Nov 19 1958	Clay, Neil K.	Acting
Mar 25 1959	Clay, Neil K.	Nominated
May 13 1959	Clay, Neil K.	Confirmed & Appointed Presidential
May 28 1959	Clay, Neil K.	Commissioned
Sep 24 1976	Taylor, James R.	Officer in charge
May 21 1977	Taylor, James R.	Appointed



HOTCHKISS / COLO.

December 4, 1898

Confirmed types of postal markings

1	Hotchkiss Colo. MS	Mscp Pen cancel	Aug 1 1885
2	HOTCHKISS / COLO. CI 10P 27.5	Hstp Target, 4 ring	May 7 1887 Jun 11 1894
3	HOTCHKISS / COLO. CI 10P 27.5	Hstp Cork, 8 piece pie (worn segments), circle of 4 "V"s; smudge	Sep 22 1898 Mar 23 1899
4	HOTCHKISS / COLO. CI 10P 28.5	Dplx Grid, 9 bar oval	Jan 9 1900 Jan 1 1903
5	HOTCHKISS / COLO. CI 10P 31.0	Dplx Grid, 9-bar oval	Feb 24 1904 Nov 28 1914
6	Hotchkiss, Colo. :: Missent to SL 00R 43.0x4.0	Aux Used on cover with straight-line Hotchkiss, same date	Oct 16 1909
7	HOTCHKISS, COLO. SL 00R 33.0x4.0	Hstp No killer; used on postal card with a Hotchkiss duplex of that same date	Oct 16 1909 Mar 6 1931 Mar 12 1936
8	HOTCHKISS, COLO. CI 10P 22.0	Flag 13 star waving flag	Sep 5 1936 Dec 7 1964
9	HOTCHKISS / COLO. CI 10P 23.0	Mach 7 wavy lines	

HOTCHKISS – Continued

10	HOTCHKISS / COLO. CI 10P 30.0	Apr 27 1944 Dec 28 1964 Dplx Grid, oval with 1
11	HOTCHKISS / COLO. CI 11P 29.0/19.0	Oct 1 1949 Hstp No killer
12	HOTCHKISS / COLO. CI 11P 30.0/19.0	Jun 26 1957 Hstp No killer
12.1	Hotchkiss / COLO. RC 10P 35.0x18.0	1950s Hstp No killer, Parcel Post Box
13	HOTCHKISS, CO / 81419 CI 10P 21.0	Sep 3 1969 May 13 1993 Mach 6 wavy lines; seen with cds inverted
14	HOTCHKISS, CO / 81419 CI 10P 31.0	Oct 7 1972 Apr 21 1988 4bars S-24x18mm
14.1	HOTCHKISS CO 81419 / USPS CI 11P 27.0/18.0	May 29, 1993 Hstp No killer
15	HOTCHKISS CO / USPS-81419 CI 11P 34.0/21.0	Apr 5 1995 Sep 22 2000 Hstp No killer
16	HOTCHKISS CO / 81419 CI 10P 34.0	Sep 22 2000 Jun 6 2001 4bars S-13x22mm

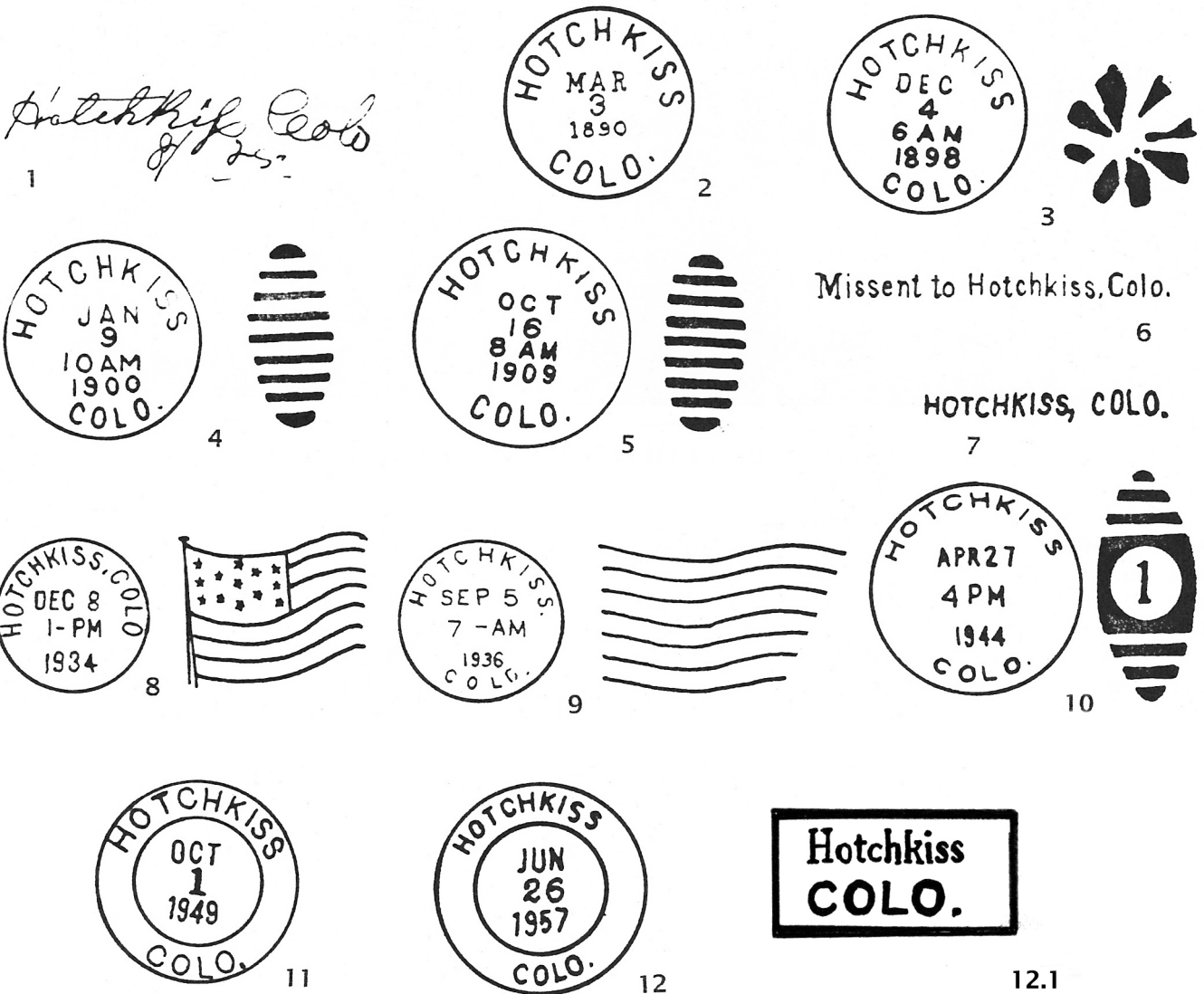

HOTCHKISS – Continued



13



14



14.1



15



16



HOTCHKISS STATIONS

100 YEARS ANNIVERSARY STATION

Chronology of the Post Office

May 6 2000 Operated as a Special Commemorative Station

Confirmed types of postal markings

- 1 HOTCHKISS CO 81419 // 100 YEAR ANNIVERSARY STATION May 6 2000
CI 10P 21.5 Pict Scene - Mountains; Text - HOTCHKISS CENTENNIAL; Station name is below the scene



1

LAZEAR

The town of Lazear was established in 1910 by B. M. Stone and was named for J. B. Lazear, a pioneer settler. Lazear was a supply point for the fruit and livestock industry of the surrounding area.

The business center of the community is on Delta County Road 3100, a mile south of Colorado Highway 92. Road 3100 is three miles west of Hotchkiss. There are a number of small residences randomly spaced along this road and in the nearby area. It is obvious that this was once a larger and more prosperous town than it is today. There are still many residences along Road 3100 but the business district is largely past history.

LAZEAR – Continued

In 2000, the Lazear Post Office was located in the same general store building where it was in 1972. That, plus an oil supply service on the other side of the street appear to comprise the business district of Lazear. The inability of stores in small towns to survive in competition with those in nearby, larger communities is an unpleasant fact of business life at the beginning of the twenty-first century.

Latitude = 38:46:48 North Longitude = 107:46:52 West

Chronology of the Post Office

Aug 31 1911	---	From: NW/4 Sec 30 T14S R93W To: NW/4 Sec 3 T15S R93W	
Jan 29 1912		Established	
Jan 29 1912		Busey, Arthur E.	
Mar 19 1912	---	SW/4 NW/4 Sec 3 T15S R93W	614 feet from depot on north side of D&RG
Feb 24 1917	---	NW/4 Sec 3 T15S R93W	
Oct 26 1920		Girling, Royden G.	
Apr 1 1923			Office made Presidential
Dec 18 1923		Girling, Royden G.	
Feb 27 1928		Girling, Royden G.	
Jul 1 1930			Relegated
Jul 11 1930		Girling, Royden G.	Confirmed
Oct 21 1930		Girling, Royden G.	Commissioned
Oct 20 1940	---	NE/4 Sec 4 T15S R93W	North Fork of the Gunnison 3/4 mile east Leroux Creek is 3 miles east of office
Aug 31 1953		Coutts, Thomas	Possession
Sep 28 1953		Coutts, Thomas	Acting
Mar 11 1954		Coutts, Thomas	Appointed
Apr 29 1954		Coutts, Thomas	Commissioned
May 16 1954		Coutts, Thomas	Possession
Jul 1 1967			Relegated
Jul 1 1967			Relegated
Aug 31 1977		Steffan, Edna L.	Officer in charge
May 3 1980		Coutts, Mrs. Sandra J.	Appointed

Confirmed types of postal markings

0.1	LAZEAR, / COLO. CI 10P 31.0	4bars S-24x19mm; letters close	Jul 17 1912 Sep 17 1912
1	LAZEAR, / COLO. CI 10P 31.5	4bars S-??x19mm	Dec 24 1915 Nov 29 1919
2	LAZEAR/ COLO. CI 10P 30.0	Dplx Grid, 9-bar oval	Sep 8 1931 Jun 2 1938
3	LAZEAR/ COLO. CI 10P 33.0	4bars S-25x20mm	Jun 21 1940 Sep 11 1948
4	LAZEAR/ COLO. CI 10P 34.0	4bars S-24x19mm	Jul 3 1949 Dec 20 1953
5	LAZEAR/ COLO. CI 10P 33.0	4bars S-??x20mm	Jan 5 1962 Apr 3 1962
6	LAZEAR, CO / 81420 CI 10P 33.0	4bars S-24x20mm	Oct ?? 1969 May 4 1976
7	LAZEAR, CO / 81420 CI 10P 32.0	4bars S-24x18mm	Dec 30 1985 Sep 22 2000

LAZEAR – Continued

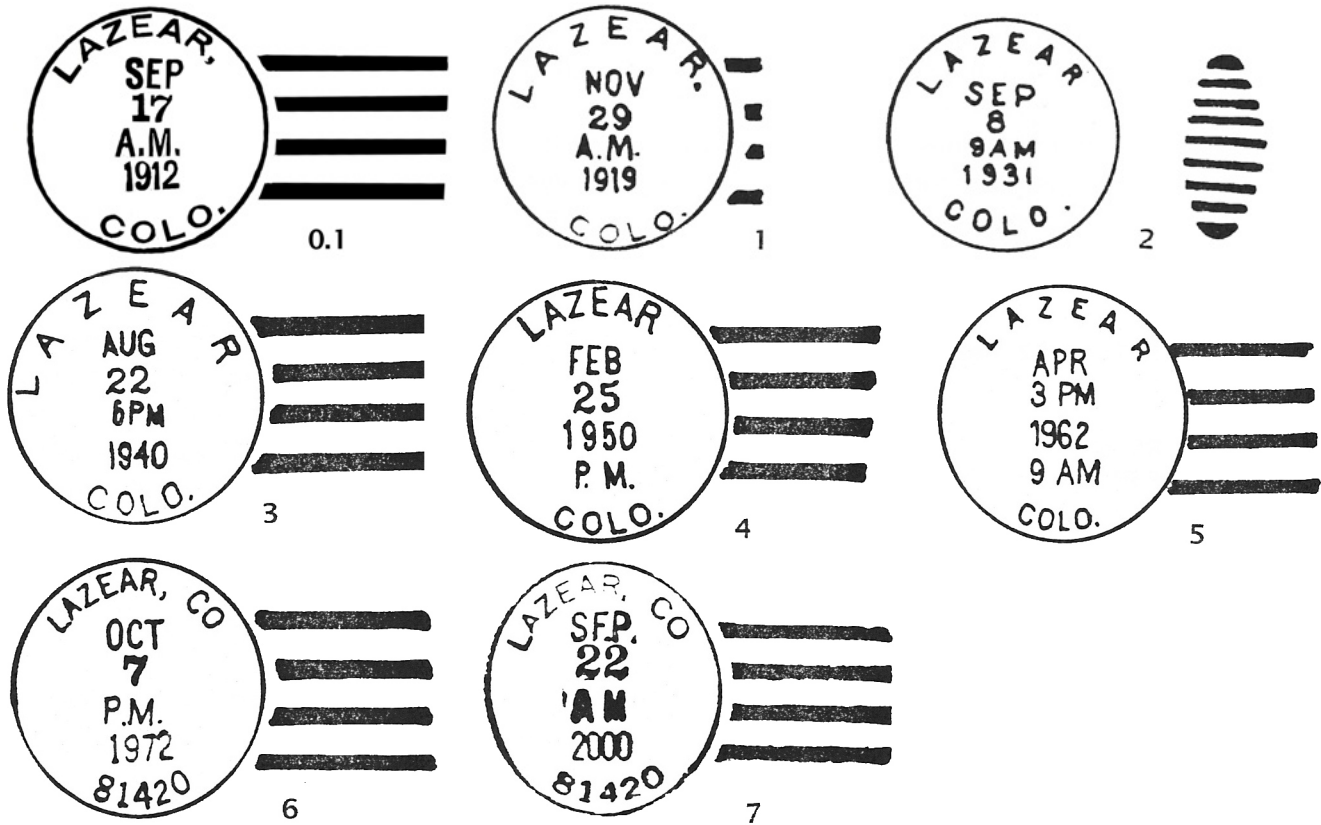

MARION

Marion was a predecessor of Austin. It came into existence when a man by the name of W. K. “Ark” Hall erected a log building at the foot of the Cory Grade. Other than that bit of information, I have found no other historical reference to this Marion. Be advised that there was intermittently (1899-1912) a Marion Post Office in Garfield County. That office was at a coal mine.

To visit the site of Marion, drive east from Delta on Colorado Highway 92 and turn north on Delta County Road 220 into the community of Austin. It is likely that the Marion Post office was along the road into Austin and between Canal Street and Highway 92.

Chronology of the Post Office

- Jan 25 1885 --- NW/4 Sec 6 T15S R94W On north side of the Gunnison East side of Currant Creek
Proposed postmaster - William Thompson
- Feb 6 1885 Established
- Feb 6 1885 Thompson, William
- Aug 27 1886 Discontinued Mail to Delta

Confirmed types of postal markings

- 1 MARION / COL.
CI 10P 27.0 Hstp Target
- Mar 19 1886 (?) Jun 20 188-



PAONIA

In 1881 Samuel Wade, a rancher, established a general merchandise store at a location on the North Fork of the Gunnison River. The settlement was briefly known locally as Wade's Ranch. In 1882 Wade submitted a request for the establishment of a post office with the name *Paeonia*, the botanical name of the peony flower. The postal authorities modified the spelling to Paonia, apparently believing that to be more appropriate. *Paeonia* is derived from Paeon, the physician of the Greek gods.

In addition to ranching, Wade planted an orchard and thus contributed to the beginnings of the fruit industry in this portion of the North Fork Valley. Paonia became a major supply point for surrounding ranches and farms and continues to enjoy that status. Paonia has a well-developed business district and many residences. The history and economic development of Paonia and Hotchkiss are similar.

Paonia gained commercial stature with the development of coal mining along the upper reaches of the North Fork. At the end of the twentieth century Paonia is home to many of those employed by the coal mines at Paonia and Bowie. There is a large coal mine at Paonia and coal from the mine at Bowie is trucked to Paonia for loading and shipment by rail to power plants for the generation of electricity.

Starting from Delta, drive east on Colorado Highway 92 to Hotchkiss. From Hotchkiss, take Colorado Highway 133 another eight miles. Paonia is approximately a half-mile south of Highway 133. The post office (September 2000) is on Grand Avenue, where it has been since at least 1972.

Latitude = 38:52:06 North Longitude = 107:35:29 West

Chronology of the Post Office

May 22 1882	---	Unsurveyed country Proposed postmaster - Samuel Wade	
Jun 7 1882		Established	
Jun 7 1882		Wade, Samuel	
Mar 31 1885	---	SW/4 Sec 6 T14S R91W 1/4 mile south of the North Fork of the Gunnison River 3/4 miles south west of Minnesota Creek	
Jan 10 1887		Edwards, Elbert F.	
Feb 5 1887		Wade, Benjamin F.	
May 16 1889		Wade, Samuel	
Mar 1 1890		McCloskey, Louis R.	
May 19 1892		Ward, Thomas C.	
May 2 1894		Goodenow, Albert S.	
Feb 20 1896		Wannemaker, John F.	
Jan 18 1900		Oliver, Rolland	
Nov 19 1903		Oliver, Rolland	P&S
Aug 15 1906		Bunker, John H.	Presidential
Dec 10 1906		Bunker, John H.	P&S
Jan 10 1911		Bunker, John H.	P&S
Nov 11 1912		Curtis, Edward H.	Acting
Jun 6 1913		Maxville, H. E.	P&S
Feb 28 1914	---	NE/4 Sec 6 T14S R91W 160 rods south of the North Fork of the Gunnison 140 rods southwest of Minnesota Creek	
Jul 21 1917		Maxville, H. E.	P&S
Feb 1 1920		Shipley, George A.	Acting
May 21 1920		Hetty, Ernest E.	P&S
Dec 1 1924		Foster, Dwight K.	Acting
Dec 9 1924		Foster, Dwight K.	Appointed
Dec 10 1928		Foster, Dwight K.	
Apr 18 1934		Hulty, Mrs. Myrtle	Nominated
May 22 1934		Hulty, Mrs. Myrtle	Confirmed
Jun 12 1934		Hulty, Mrs. Myrtle	Commissioned
Apr 29 1938		Hulty, Mrs. Myrtle	Nominated
May 3 1938		Hulty, Mrs. Myrtle	Confirmed

PAONIA – Continued

May 22 1938	Hulty, Mrs. Myrtle	Appointed Presidential
May 23 1938	Hulty, Mrs. Myrtle	Commissioned
Oct 22 1941 ---	T14S R91W (Grand Avenue) North Fork of the Gunnison	3 blocks north of office
Jun 6 1944	Wand, Thomas H.	Nominated
Jun 15 1944	Wand, Thomas H.	Confirmed
Jun 16 1944	Wand, Thomas H.	Appointed Presidential & Commissioned
Sep 1 1944	Wand, Thomas H.	Assumed charge
Dec 31 1956	Henry, Merrill E.	Acting & Assumed charge
Jan 14 1957	Henry, Merrill E.	Acting
Jun 10 1957	Simpson, Lloyd E.	Nominated
Aug 5 1957	Simpson, Lloyd E.	Confirmed
Aug 6 1957	Simpson, Lloyd E.	Appointed Presidential & Commissioned
Sep 6 1957	Simpson, Lloyd E.	Assumed charge
Jun 27 1972	Wood, Donald	Officer in charge
Sep 16 1972	Wood, Donald	Appointed
Aug 31 1979	Swensen, Darlene E.	Officer in charge
Jan 26 1980	Dobbs, David E.	Appointed

Confirmed types of postal markings

1	PAONIA, / COLORADO. CI 20H 29.0/25.0	Hstp Pen cancel	Sep 14 1887 Jan 18 1890
1.1	PAONIA / DELTA CO., COLO. CI 10P 28.0	Hstp Not present	Jun 26 1894 Jun 27 1894
2	PAONIA / COLO. CI 10P 27.0	Hstp Grid, 7 bar circular	Feb 12 1895 Mar 1 1900
3	PAONIA / COLO. CI 10P 30.0	Dplx Grid, 8 bar oval	Dec 20 1903 May 24 1926
3.1	PAONIA, COLO. / REGISTERED CI 11P 28.5/18.5	Hstp No killer [NOT AVAILABLE FOR ILLUSTRATION]	Dec 1 1923
4	PAONIA / COLO. CI 10P 25.0	Dplx Grid, 9 bar oval	Jan 31 1927 Jun 15 1939
5	PAONIA, / COLO. CI 10P 21.0	Mach 7 wavy lines	Oct 27 1930 May 4 1961
6	PAONIA, COLO. / REGISTERED CI 11P 29.0/19.0	Hstp No killer	Jun 13 1923 Sep 19 1936
7	PAONIA, COLO. / REGISTERED CI 11P 29.0/18.0	Hstp No killer	Jul 9 1946 Aug 9 1955
7.1	PAONIA, / COLO. RC 10P 35.0x17.5	Hstp No killer, Parcel Post Box	1950s
8	PAONIA / COLO. CI 10P 33.0	4bars S-24x20mm	May 6 1957 Apr 25 1960
9	PAONIA, COLO. CI 10P 21.0	Mach 7 wavy lines	Oct 15 1962 Aug 3 1964
10	PAONIA, CO / 81428 CI 10P 31.0	4bars S-24x18mm	Mar 23 1969 Jul 1 1971
11	PAONIA, CO 81428 CI 10P 21.0	Mach 7 wavy lines	Feb 28 1972 Oct 4 1978
12	PAONIA, CO / 81428 CI 10P 33.0	4bars S-24x20mm	Oct 7 1972 Apr 14 1992
13	PAONIA, CO / 81428 CI 10P 21.0	Mach 7 wavy lines	Dec 21 1982 Jul 27 2000
14	PAONIA CO / 81428 CI 10P 33.0	4bars S-20x16mm	Sep 22 2000
15	PAONIA CO 81428 / USPS CI 11P 29.0/19.0	Hstp No killer	Sep 22 2000
16	PAONIA CO 81428 / USPS CI 11P 30.0/22.0	Hstp No killer	Jun 22 2001 Jul 8 2002

PAONIA - Continued



1



1.1



2



3

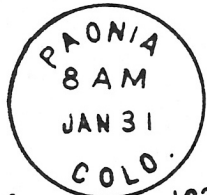

4

1927



5

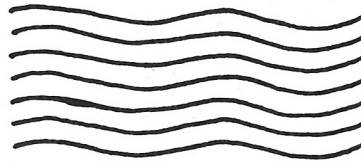

6



7



7.1

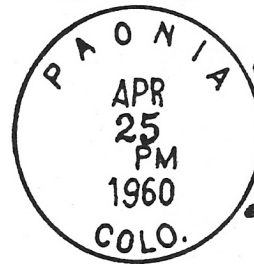

8

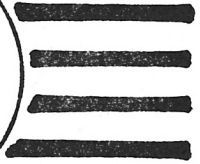

9

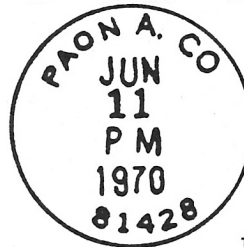
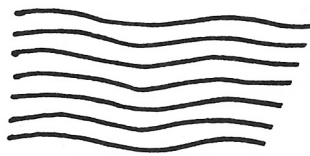

10



11

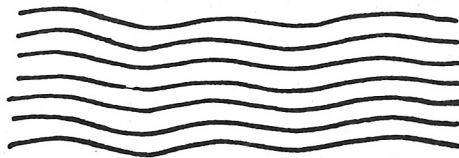

12

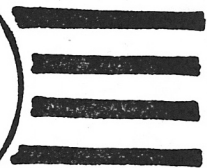

13



14



15

PAONIA – Continued

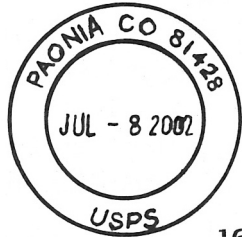

16

PAONIA STATIONS

CENTENNIAL CELEBRATION STATION

Chronology of the Post Office

Jul 4 2002 Operated as a Special Commemorative Station

Confirmed types of postal markings

- 1 Paonia, Colorado 81428 // Centennial Celebration Station Jul 4 2002
IR 00R 93.0x43.0 Pict Scene - Mountains, train, agricultural items;
Text - Paonia Centennial Then and Now /
1902-2002 :: Paonia Town Park / 700 Fourth Street



July 4, 2002
Centennial Celebration Station
Paonia Town Park
700 Fourth Street
Paonia, Colorado 81428

1

PAONIA CHERRY DAYS 50TH ANNIVERSARY STATION

Chronology of the Post Office

Jul 4 1996 Operated as a Special Commemorative Station

Confirmed types of postal markings

- 1 PAONIA CO 81428-9998 // PAONIA CHERRY DAYS / 50TH ANNIV. STATION Jul 4 1996
IR 00R 65.0x23.0 Pict Scene - Cherries - Text: Paonia's / 50th /
Cherry Days / 1996 / Treasured Memories



July 4, 1996

PAONIA CHERRY DAYS
50TH ANNIVERSARY STATION
PAONIA CO 81428-9998

1

READ – Continued



Read, Colorado – Junction of Colorado Highway 92 and County Road H75
Photograph by William H. Bauer September 22, 2000

Chronology of the Post Office

- Jan 22 1898 --- NE/4 Sec 11 T15S R95W 1/4 mile south of the Gunnison River
Proposed postmaster - John W. Charleston
- Apr 22 1898 Established
- Apr 22 1898 Charleston, John W.
- Mar 31 1900 Whinnery, Ralph V.
- Apr 15 1907 Harrison, Elmore C.
- Jan 11 1908 Davis, Philander D.
- Feb 25 1914 --- NE/4 NE/4 Sec 11 T15S R95W 1/4 mile south of the Gunnison River
- Jan 23 1915 Davis, Mirtie
- Feb 18 1916 Whiteside, John F.
- Oct 7 1919 Billstrom, Gustavus A. Failed to qualify
- Mar 12 1920 --- SE/4 NE/4 Sec 11 T15S R95W About 1/4 mile south of the Gunnison River
1-3/8 miles southwest of Dry Creek
- Jul 15 1920 Pritchard, Millard H.
- Jan 8 1934 Ordered closed
- Jan 31 1934 Discontinued Mail to Delta

Confirmed types of postal markings

- | | | | |
|---|-----------------------------|--------------------------|-------------------------|
| 1 | Read, Colo.
MS | Mscp Pen cancel | May 23 1898 |
| 2 | READ / COLO.
CI 10P 28.0 | Hstp Target, 4-ring 17mm | Feb 28 1899 Mar 17 1900 |
| 3 | READ / COLO.
CI 10P 30.0 | 4bars S-??x14mm | Jun 6 1909 Sep 1 1911 |

READ – Continued

- | | | | |
|---|------------------------------|-----------------|------------------------|
| 4 | READ, / COLO.
CI 10P 32.0 | 4bars S-24x20mm | Dec 5 1912 Nov 23 1915 |
| 5 | READ, / COLO.
CI 10P 32.0 | 4bars S-25x19mm | Dec 7 1931 Jan 31 1934 |

*Read
5-23-94
Colo*

1

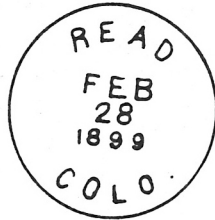

2

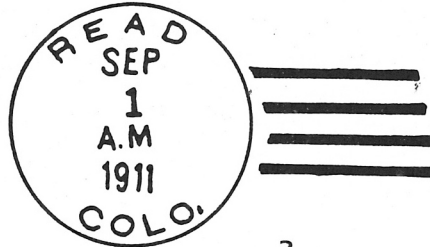

3

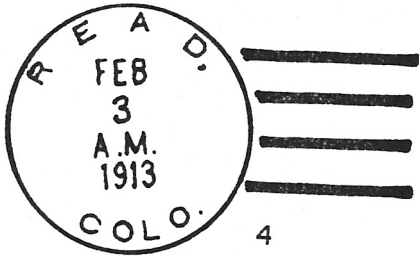

4

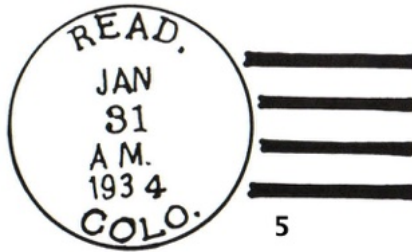

5

ROUBIDEAU

There is a question concerning the location of this post office. The Federal Land Survey location specified in the Post Office Department Geographical Site Location Report is about three miles southeast of Austin in Peach Valley. However, all mentions of Roubideau that I have found in historical literature refer to a location about five miles west of Delta on the Gunnison River, the Denver and Rio Grande Railroad and the east side of Roubideau Creek. It is more confusing that the verbal description of the location, as given in the Site Location Report, fits this place west of Delta. Perhaps, on my next visit to this area, I will investigate this other location.

It is not uncommon in Colorado to have the same name applied to a post office and to a railroad station and/or siding but which are at considerably different locations. For now, without more information, I will accept the Post Office Department's survey location for the Roubideau Post Office.

The name Roubideau was for Antoine Roubideau, a French fur trader operating out of St. Louis, Missouri. His name has also been spelled Robideau, Robidoux and Roubidoux. In 1837 Roubideau constructed Fort Uncompahgre, a short-lived trading post near Delta. Captain John W. Gunnison noted the ruins of this fort when he passed through the area on his 1853 journey of exploration.

To visit or observe, the Post Office Department's location for Roubideau: From Colorado Highway 92, drive south on Delta County Road 220 (the road into Austin) one mile to County Road H75. Turn east on H75 and keep to the right at a fork in the road. The road then bears southeast around the base of Smiths Mountain. Go about two miles to where the road turns east at the south end of Smiths Mountain. There is a slight rise here from where you can look southwest over the claimed location for Roubideau. There is really nothing to be seen and there is no access to the exact location, unless you want to walk out across a rather barren, sagebrush covered flat.

If this was the site of Roubideau, I doubt that it was more than a ranch that had only a brief and unsuccessful period of existence.

ROUBIDEAU – Continued

ADDITIONAL INFORMATION

The following was included in *High Country Wanderings*, Volume 19, Number 1.

In the spring, Jim Ozment and I once again set off for the Western Slope. It was a “catch-up” tour, to visit several sites that for one reason or another we had passed on during previous trips. Included were two places in Delta County, Roubideau and Escalante, for which my information had been in error. In the case of Escalante I simply went down the wrong road. Roubideau is still a puzzle. The Post Office Department location is several miles east of Delta but the true location is a few miles west of Delta. My only explanation is that there was a change in the Federal Land Survey subsequent to the original report.

To reach what I now believe to be the correct site for Roubideau, from Delta, drive west on Fifth Street keeping straight at a fork in the road. The road goes up over a low hill then drops back down into a wide level valley. From the hill, looking down into the valley you are overlooking the site of Roubideau, which was along the south side of the railroad. Roubideau was at the western end of the siding. There is an historical marker and signs of plenty of activity but no structures remain.

Latitude = 38:44:08 North Longitude = 108:09:00 West

Chronology of the Post Office

Feb 27 1909	Established
Feb 27 1909	Edwards, Charles M.
Apr 20 1909	--- SE/4 Sec 17 T15S R94W 1/4 mile south of the Gunnison River 3/4 mile east of Roubideaux Creek
Feb 20 1911	Edwards, Raymond C.
Feb 12 1914	Blumberg, Charles
Jul 15, 1918	Discontinued Mail to Delta

Confirmed types of postal markings

0.1	ROUBIDEAU, / COLO. CI 10P 32.0	4bars S-24x13mm	Sep 9 1909
1	ROUBIDEAU. / COLO. CI 10P 32.0	4bars S-24x19mm	May 7 1913 Jun 11 1914

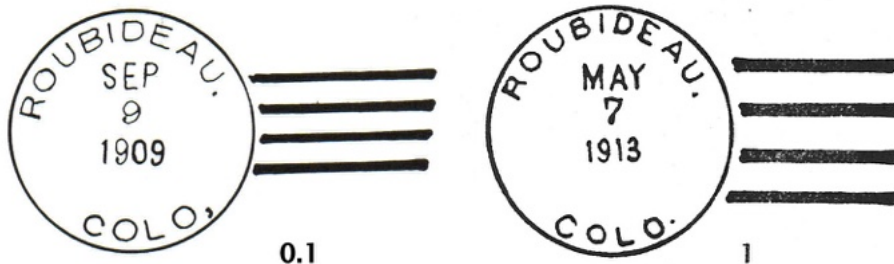

SUTTLE

The information in historical literature that references Suttle is sparse indeed. All that I have found are brief referrals to maps that place it northeast of Cedaredge and between the headwaters of Surface Creek and Currant Creek. The Post Office Department Geographic Site Location Report states that it was in an unsurveyed area and that it was on Surface Creek. From that document it appears that it was named for its first and only postmaster: Andrew P. Suttle. I further assume that it was a ranch post office intended to serve a few families in a rather remote area on the slope of Grand Mesa.

SUTTLE – Continued

In September 2000, with only that fragmentary information, I set out to see if I could find anything that seemed reasonable as a location for Suttle.

From Cedaredge I drove three and one-half miles north on Colorado Highway 65 to Delta County Road U 50. From there I went east 1.7 miles to Road 2500 and turned north on that road. In another two miles the pavement ended and after another mile the road makes a sharp right-hand turn for a few hundred feet before again turning north. At that point I found the Bryce Lodge, a rather rustic appearing guest ranch. From its appearance it has been there as a ranch for a long time. Since it was the only thing in the area that indicated habitation, I will, for now, accept it as the possible site of the Suttle Post Office. Perhaps a search of historical property records would better identify where Andrew P. Suttle lived.

Chronology of the Post Office

- Aug 24 1882 --- **Unsurveyed On Surface Creek**
 NOTE: "I suggest Andrew P. Suttle for P.M. (David B Parker Chief PO Insp)"
- Aug 25 1882 **Established**
- Aug 25 1882 **Suttle, Andrew P.**
- Apr 12 1883 **Discontinued Mail to Hawxhurst**
 NOTE: It is odd, that when this office was discontinued, mail was to be sent to Hawxhurst (now Collbran). That would have been a long, difficult trip over Grand Mesa. Perhaps settlement at Suttle and vicinity simply ceased to exist until years later.

Confirmed types of postal markings

NO POSTAL MARKINGS HAVE BEEN REPORTED FROM SUTTLE

VERNE

I have found no mention of Verne in the historical literature of Delta County. Also, there is no Geographic Site Location Report in the Delta County file. This is not too surprising as the establishment was rescinded in less than three months.

I can speculate that it was a ranch or farm that would have served surrounding families and that it may have been judged unnecessary and quickly rescinded in the face of the expanding Rural Free Delivery system.

Chronology of the Post Office

- Oct 12,1903 **Established**
- Oct 12 1903 **Eavenson, George** **Order rescinded Dec 30 1903**
- Dec 30,1903 **Discontinued or Establishment rescinded**

Confirmed types of postal markings

NO POSTAL MARKINGS HAVE BEEN REPORTED FROM VERNE

WELCOME

Welcome is another of the Delta County post offices that have not been mentioned in the county's historical literature. However, there is a Geographic Site Location Report from which the site can be determined. I have also been fortunate enough to meet someone from the area that was knowledgeable about Welcome and confirmed the location I have spotted.

To get to the site of Welcome, start in Eckert and drive east on Delta County Road N. To the west (of Highway 65) this road is marked as leading to the county's sanitary landfill. Six and one-half miles east of Eckert turn north on County Road 2649 for a half-mile, then east on County Road N (once again). A half-mile further and you pass an older farmstead on the south side of the road. This was the site of the Welcome Post Office.

WELCOME – Continued

From what one can see of the surrounding countryside, this was another rural ranch post office that for a few short years served surrounding ranches and farms. It was likely another casualty of the expanding Rural Free Delivery system.

[SRM Note: Alternate directions that lead to the site of Welcome have been given to me by someone who had recently visited the site.]

To get to the site of Welcome, start in Eckert, which is an incorporated part of Delta County and has been absorbed by Orchard City. Go east on North Road about 6 miles, it is straight until you come to several gullies, including one big one called Madison Gulch. Keep the faith and stay on North Road as it wanders around. After you emerge from the Gulch, North Road straightens out. Go east until you hit 2640 Road, and turn left and go north about half a mile to a right turn only and it becomes North Road again. Go about a half mile on North Road, and on the south side of the road was the site of Welcome.

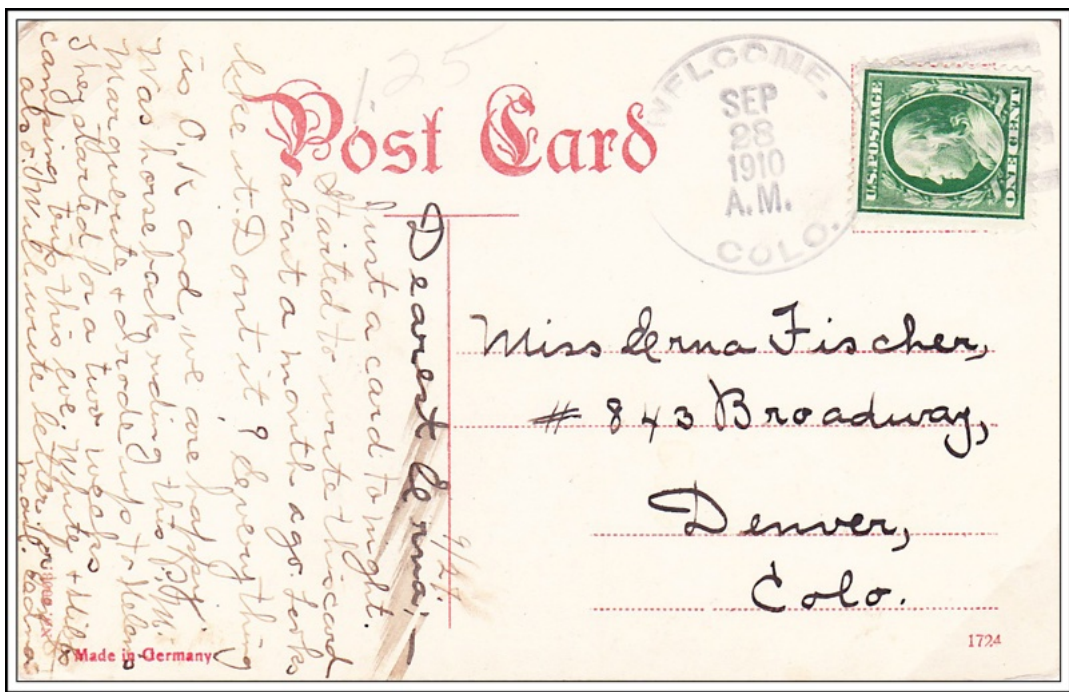

WELCOME, / COLO. September 28, 1910

Chronology of the Post Office

- Aug 24 1909 --- NW/4 NE/4 Sec 14 T14S R94W Gunnison river 5 miles south
Dry Creek three miles west of office
- Jun 22 1910 Established
- Jun 22 1910 Eavenson, George
- Aug 31 1912 Discontinued

Confirmed types of postal markings

- | | | | |
|---|---------------------------------|-----------------|-------------------------|
| 1 | Welcome / Colo
MS | Mscp Pen cancel | Sep 3 1910 |
| 2 | WELCOME. / COLO.
CI 10P 31.5 | 4bars S-24x19mm | Sep 28 1910 Dec 31 1910 |

WELCOME – Continued

*Welcome
Colo
9-3-10*

1



2

BIBLIOGRAPHY – DELTA COUNTY**REFERENCES – BOOKS**

- AUSTIN, Hazel Baker *Surface Creek Country*; 1977; Printed by the Delta County Independent; 56 pp; illus.; map
- BENSON, Maxine *1001 Colorado Place Names*; 1994; University Press of Kansas; Lawrence, Kansas; 237 pp; sketches
- CROFUTT, George A. *Crofutt's Gripsack Guide of Colorado*, 1885; Overland Publishing Co; Omaha, Nebraska; Reprint: Cubar Associates; 1966; Golden, Colorado; 266pp; illus.; maps
- DAWSON, J. Frank *Place Names in Colorado*; 1954; J. Frank Dawson Publishing Co.; Denver, Colorado; 52 pp
- EICHLER, George R. *Colorado Place Names*; 1977; Johnson Publishing Co.; Boulder, Colorado; 109 pp; illus.
- GRISWOLD, Don and Jean *Colorado's Century of Cities*; 1958; Smith-Brooks; 307 pp; illus.
- ROCKWELL, Wilson *Uncompahgre Country*; 1965; Sage Books, Denver, Colorado; 310 pp; illus.

REFERENCES – COLORADO MAGAZINE

- BORLAND, Lois *Ho for the Reservation: Settlement of the Western Slope*; January 1952, Vol. 29, No. 1, pp 56-75
- HILL, Joseph J. *Antoine Roubidoux, Kingpin in the Colorado River Fur Trade 1824-1844*; July 1930, Vol. 7, No. 4, pp 125-132
- ROCKWELL, Wilson M. *The Fruit Utopia on the North Fork of the Gunnison*; May 1938, Vol. 15, No. 3, pp 89-98
- WADE, Ezra G *Early Days of Paonia*; March 1927, Vol. 4, No. 2, pp 66-70
- Place Names in Colorado* [Alternate Title: *The Names of Colorado Towns*]
Prepared by the Colorado Writers Project; *Colorado Magazine*; Serialized in Volumes 17-20

GEOGRAPHIC SITE LOCATION REPORTS OF THE POST OFFICE DEPARTMENT

These are documents filed with applications for the approval of a new post office, at the time of a move of a post office and upon periodic requests of the Post Office Department. The documents may include a detailed location using the Federal Land Survey System, reference of distance to local streams and rivers, to railroads and to nearby existing post offices.

A GALLERY OF DELTA COUNTY COVERS

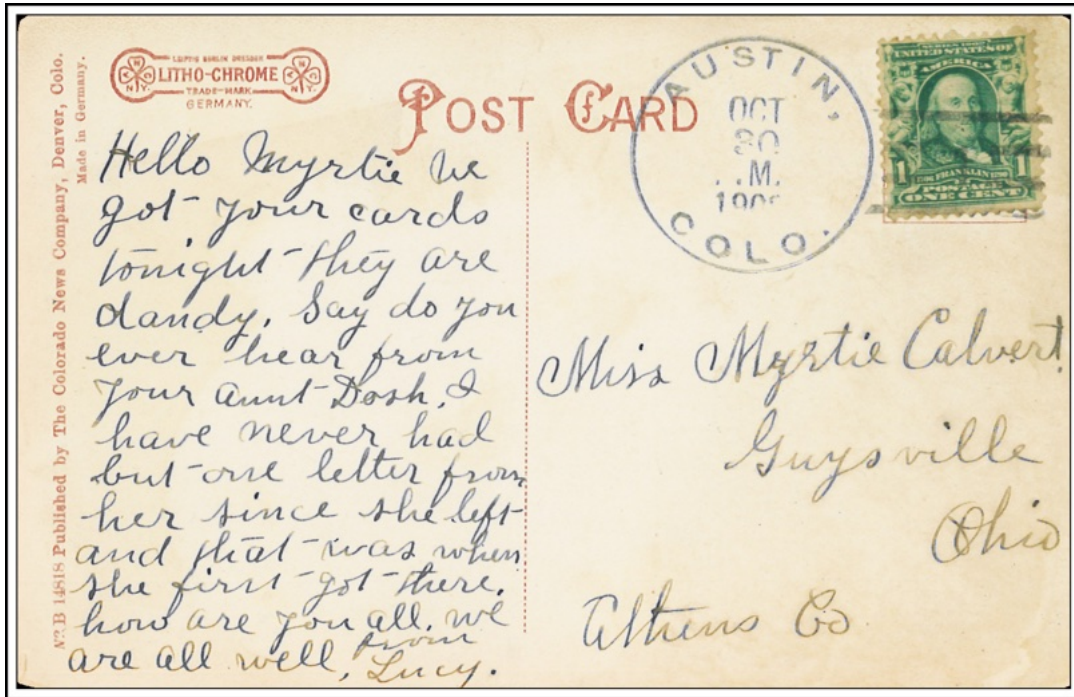

AUSTIN, / COLO.

October 30, 190-



CEDAREGE. / COLO. July 18, 1907

Note the wavy 4 bars



COALBY, / COLO.

June 30, 1911

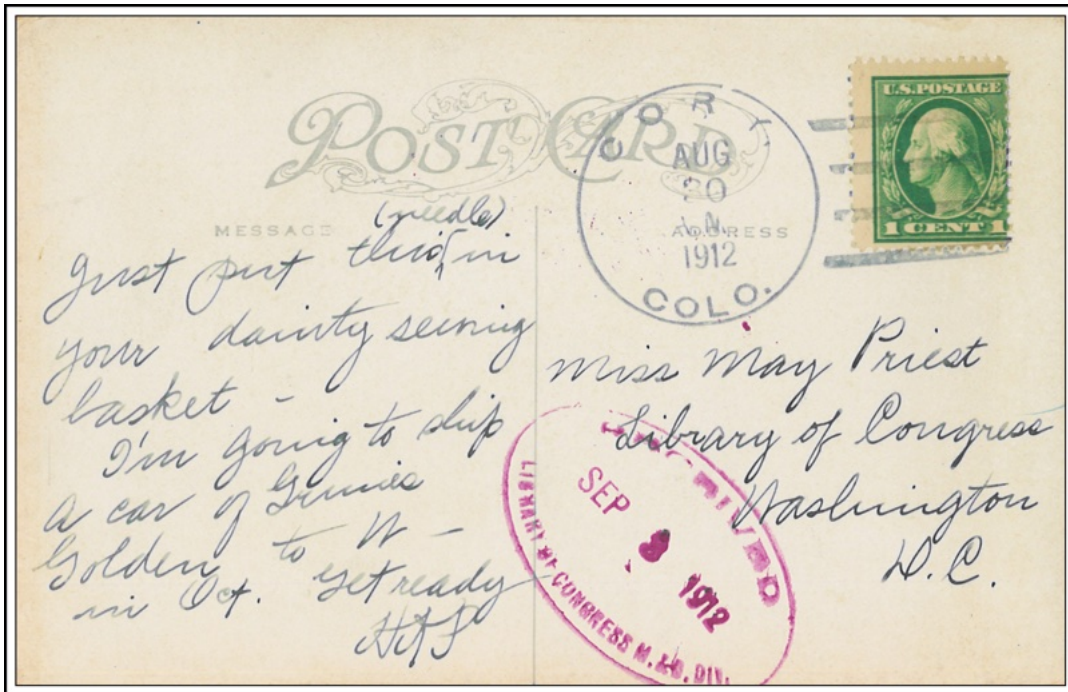

CORY, / COLO.

August 30, 1912



Delta Col

July 7, 1883

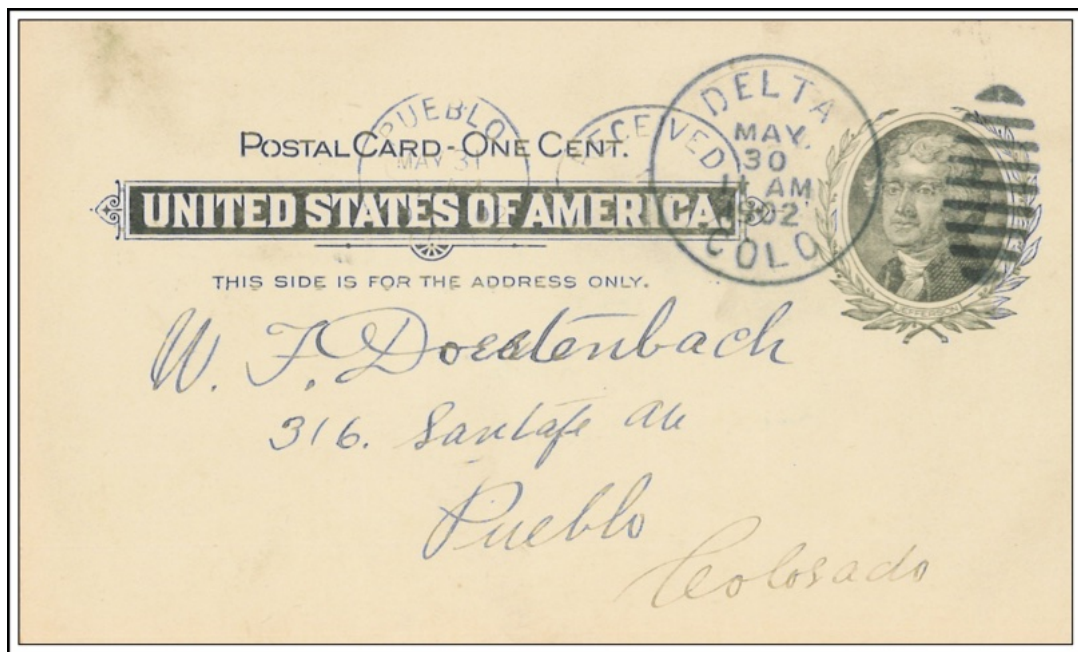

DELTA / COLO.

May 30, 1902

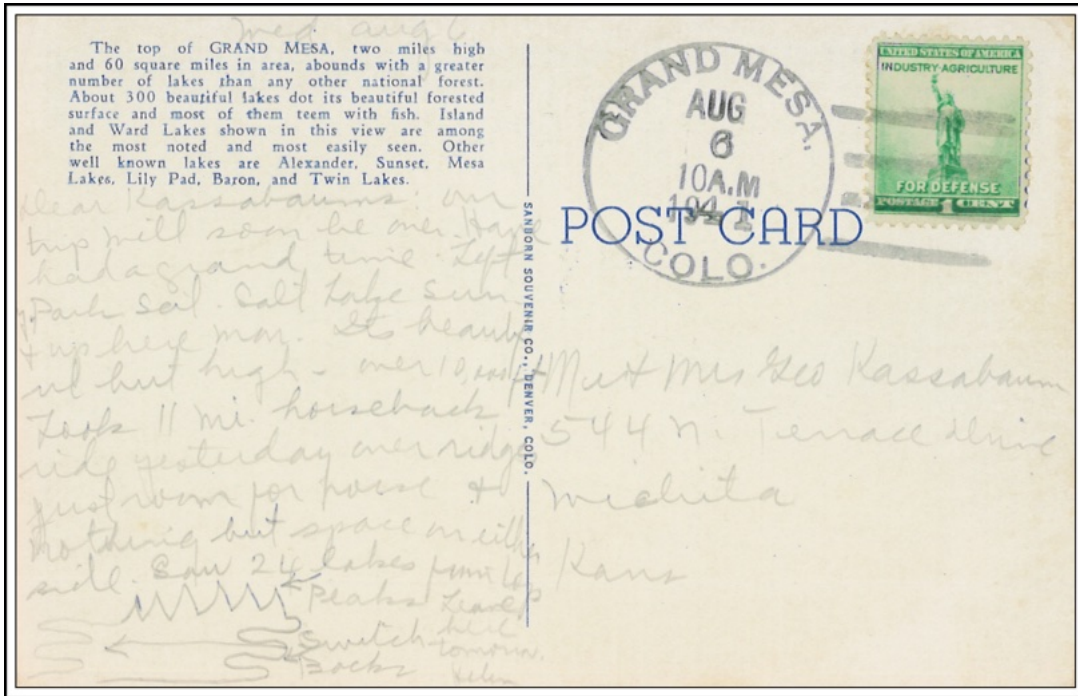

GRAND MESA, / COLO.

August 6, 1941

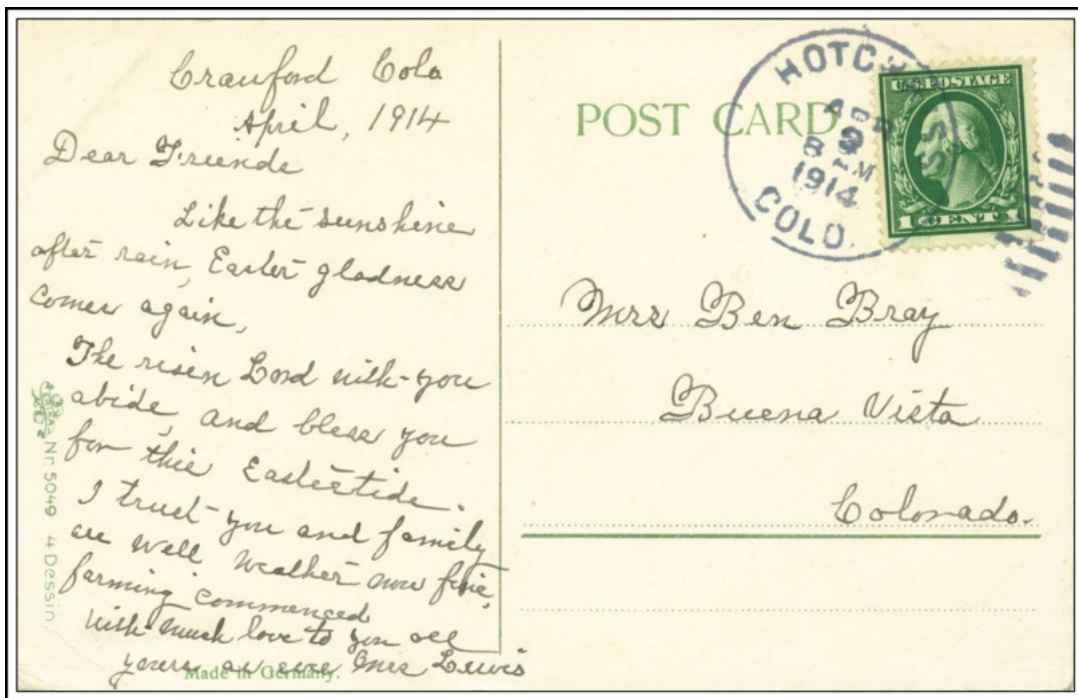

HOTCHKISS / COLO.

April 9, 1914

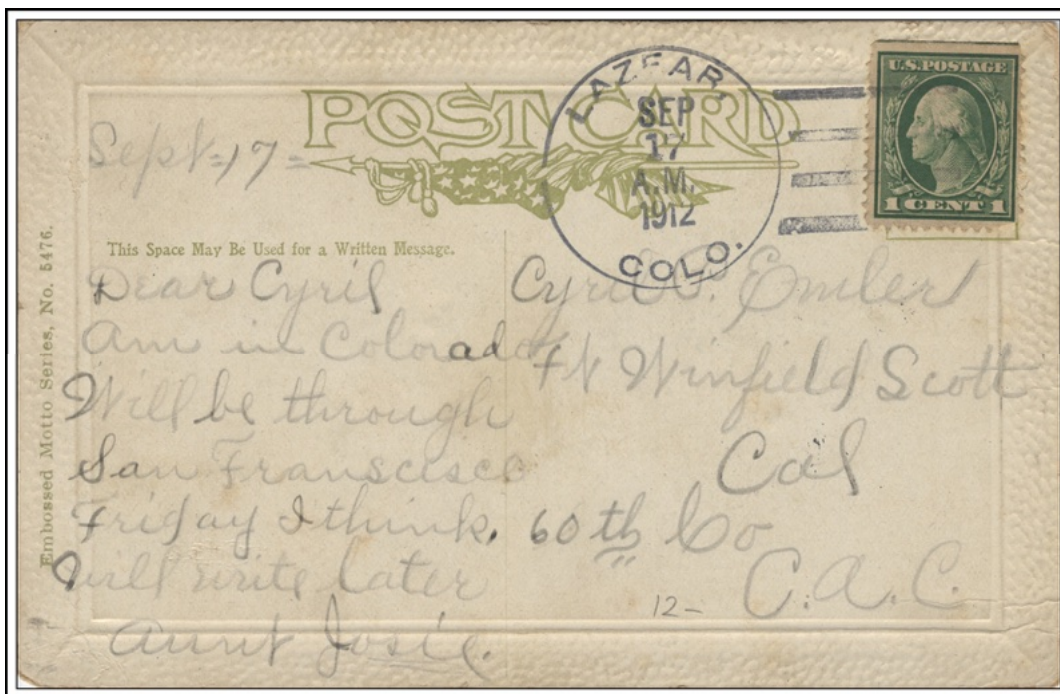

LAZEAR, / COLO.

September 17, 1912



PAONIA, / COLORADO.

August 16, 1889

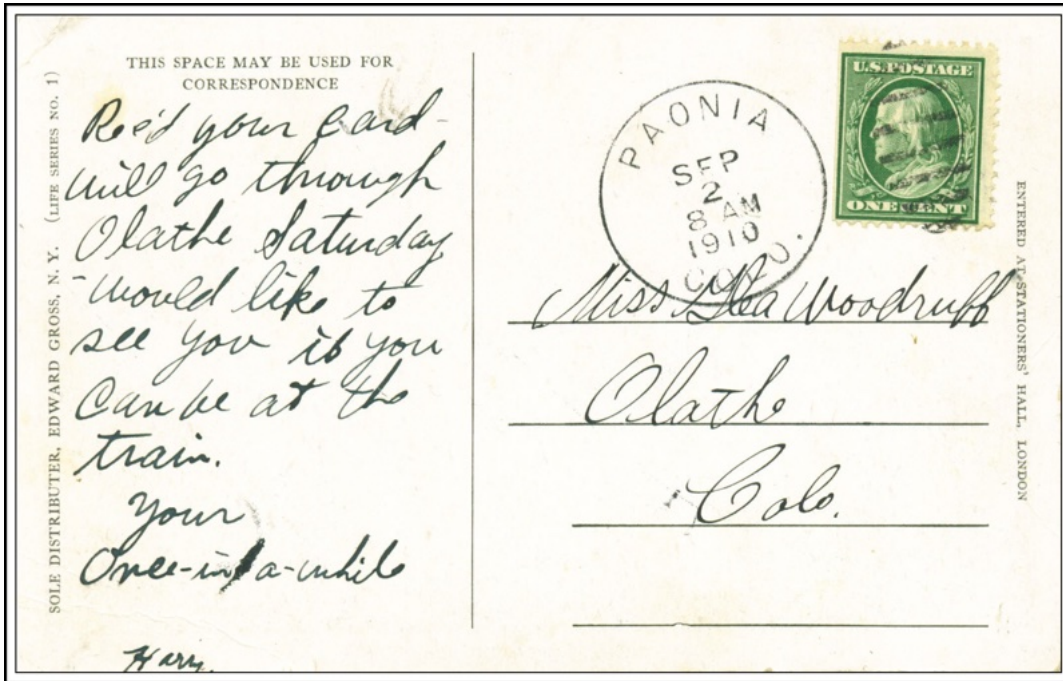

PAONIA / COLO.

September 2, 1910

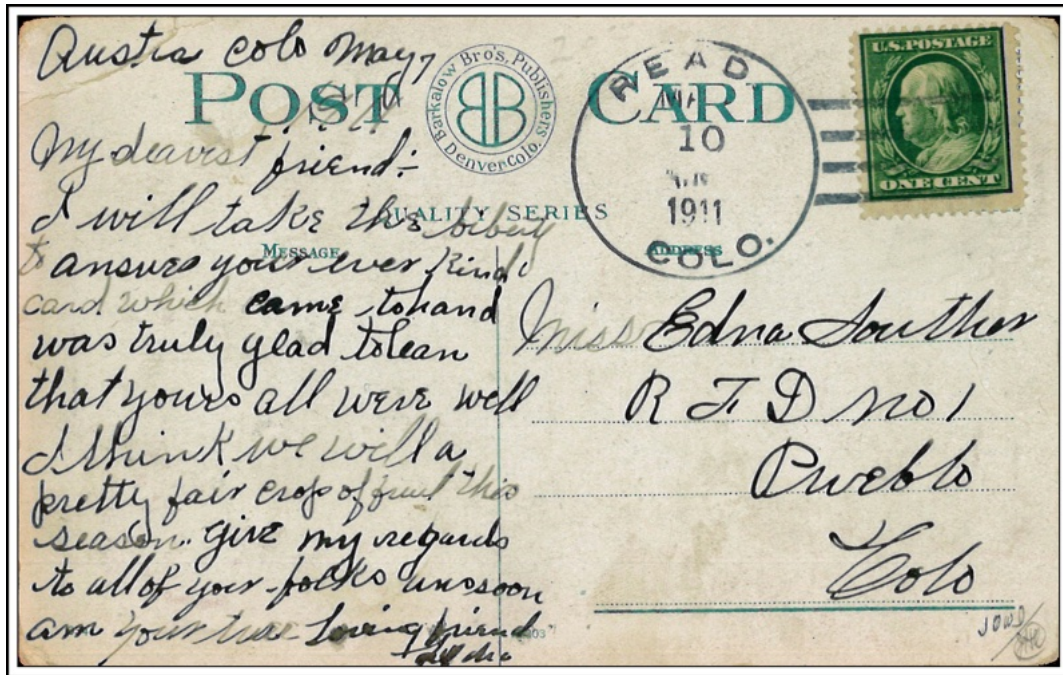

READ / COLO.

May 10, 1911